

Extremal Graph Theory for Metric Dimension and Diameter*

Carmen Hernando[†]

Departament de Matemàtica Aplicada I
Universitat Politècnica de Catalunya
Barcelona, Spain

carmen.hernando@upc.edu

Mercè Mora[†]

Departament de Matemàtica Aplicada II
Universitat Politècnica de Catalunya
Barcelona, Spain

merce.mora@upc.edu

Ignacio M. Pelayo[‡]

Departament de Matemàtica Aplicada III
Universitat Politècnica de Catalunya
Barcelona, Spain

ignacio.m.pelayo@upc.edu

Carlos Seara[†]

Departament de Matemàtica Aplicada II
Universitat Politècnica de Catalunya
Barcelona, Spain

carlos.seara@upc.edu

David R. Wood[§]

Department of Mathematics and Statistics
The University of Melbourne
Melbourne, Australia

woodd@unimelb.edu.au

Submitted: Jul 31, 2008; Accepted: Feb 11, 2010; Published: Feb 22, 2010

Subject Classification: 05C12 (distance in graphs), 05C35 (extremal graph theory)

Keywords: graph, distance, resolving set, metric dimension, metric basis, diameter, order

*An extended abstract of this paper was presented at the European Conference on Combinatorics, Graph Theory and Applications (EuroComb '07), *Electronic Notes in Discrete Mathematics* 29:339-343, 2007.

[†]Research supported by project MTM2009-07242 and Gen. Cat. DGR 2009SGR1040.

[‡]Research supported by projects MTM2008-06620-C03-01 and 2009SGR-1387.

[§]Supported by a QEII Research Fellowship. Research conducted at the Universitat Politècnica de Catalunya, where supported by a Marie Curie Fellowship under contract MEIF-CT-2006-023865, and by projects MEC MTM2006-01267 and DURSI 2005SGR00692.

Abstract

A set of vertices S *resolves* a connected graph G if every vertex is uniquely determined by its vector of distances to the vertices in S . The *metric dimension* of G is the minimum cardinality of a resolving set of G . Let $\mathcal{G}_{\beta,D}$ be the set of graphs with metric dimension β and diameter D . It is well-known that the minimum order of a graph in $\mathcal{G}_{\beta,D}$ is exactly $\beta + D$. The first contribution of this paper is to characterise the graphs in $\mathcal{G}_{\beta,D}$ with order $\beta + D$ for all values of β and D . Such a characterisation was previously only known for $D \leq 2$ or $\beta \leq 1$. The second contribution is to determine the maximum order of a graph in $\mathcal{G}_{\beta,D}$ for all values of D and β . Only a weak upper bound was previously known.

1 Introduction

Resolving sets in graphs, first introduced by Slater [36] and Harary and Melter [16], have since been widely investigated [2, 3, 4, 5, 6, 7, 9, 17, 18, 19, 21, 23, 24, 25, 26, 27, 28, 29, 30, 31, 32, 33, 34, 35, 37, 39, 40, 41, 42]. They arise in diverse areas including coin weighing problems [11, 15, 20, 22, 38], network discovery and verification [1], robot navigation [21, 35], connected joins in graphs [34], the Djoković-Winkler relation [3], and strategies for the Mastermind game [8, 12, 13, 14, 20].

Let G be a connected graph¹. A vertex $x \in V(G)$ *resolves*² a pair of vertices $v, w \in V(G)$ if $\text{dist}(v, x) \neq \text{dist}(w, x)$. A set of vertices $S \subseteq V(G)$ *resolves* G , and S is a *resolving set* of G , if every pair of distinct vertices of G is resolved by some vertex in S . Informally, S resolves G if every vertex of G is uniquely determined by its vector of distances to the vertices in S . A resolving set S of G with the minimum cardinality is a *metric basis* of G , and $|S|$ is the *metric dimension* of G , denoted by $\beta(G)$.

For positive integers β and D , let $\mathcal{G}_{\beta,D}$ be the class of connected graphs with metric dimension β and diameter D . Consider the following two extremal questions:

- What is the minimum order of a graph in $\mathcal{G}_{\beta,D}$?
- What is the maximum order of a graph in $\mathcal{G}_{\beta,D}$?

¹Graphs in this paper are finite, undirected, and simple. The vertex set and edge set of a graph G are denoted by $V(G)$ and $E(G)$. For vertices $v, w \in V(G)$, we write $v \sim w$ if $vw \in E(G)$, and $v \not\sim w$ if $vw \notin E(G)$. For $S \subseteq V(G)$, let $G[S]$ be the subgraph of G induced by S . That is, $V(G[S]) = S$ and $E(G[S]) = \{vw \in E(G) : v \in S, w \in S\}$. For $S \subseteq V(G)$, let $G \setminus S$ be the graph $G[V(G) \setminus S]$. For $v \in V(G)$, let $G \setminus v$ be the graph $G \setminus \{v\}$. Now suppose that G is connected. The *distance* between vertices $v, w \in V(G)$, denoted by $\text{dist}_G(v, w)$, is the length (that is, the number of edges) in a shortest path between v and w in G . The *eccentricity* of a vertex v in G is $\text{ecc}_G(v) := \max\{\text{dist}_G(v, w) : w \in V(G)\}$. We drop the subscript G from these notations if the graph G is clear from the context. The *diameter* of G is $\text{diam}(G) := \max\{\text{dist}(v, w) : v, w \in V(G)\} = \max\{\text{ecc}(v) : v \in V(G)\}$. For integers $a \leq b$, let $[a, b] := \{a, a + 1, \dots, b\}$. Undefined terminology can be found in [10].

²It will be convenient to also use the following definitions for a connected graph G . A vertex $x \in V(G)$ *resolves* a set of vertices $T \subseteq V(G)$ if x resolves every pair of distinct vertices in T . A set of vertices $S \subseteq V(G)$ *resolves* a set of vertices $T \subseteq V(G)$ if for every pair of distinct vertices $v, w \in T$, there exists a vertex $x \in S$ that resolves v, w .

The first question was independently answered by Yushmanov [42], Khuller et al. [21], and Chartrand et al. [5], who proved that the minimum order of a graph in $\mathcal{G}_{\beta,D}$ is $\beta + D$ (see Lemma 2.2). Thus it is natural to consider the following problem:

- Characterise the graphs in $\mathcal{G}_{\beta,D}$ with order $\beta + D$.

Such a characterisation is simple for $\beta = 1$. In particular, Khuller et al. [21] and Chartrand et al. [5] independently proved that paths P_n (with $n \geq 2$ vertices) are the only graphs with metric dimension 1. Thus $\mathcal{G}_{1,D} = \{P_{D+1}\}$.

The characterisation is again simple at the other extreme with $D = 1$. In particular, Chartrand et al. [5] proved that the complete graph K_n (with $n \geq 1$ vertices) is the only graph with metric dimension $n - 1$ (see Proposition 2.12). Thus $\mathcal{G}_{\beta,1} = \{K_{\beta+1}\}$.

Chartrand et al. [5] studied the case $D = 2$, and obtained a non-trivial characterisation of graphs in $\mathcal{G}_{\beta,2}$ with order $\beta + 2$ (see Proposition 2.13).

The first contribution of this paper is to characterise the graphs in $\mathcal{G}_{\beta,D}$ with order $\beta + D$ for all values of $\beta \geq 1$ and $D \geq 3$, thus completing the characterisation for all values of D . This result is stated and proved in Section 2.

We then study the second question above: What is the maximum order of a graph in $\mathcal{G}_{\beta,D}$? Previously, only a weak upper bound was known. In particular, Khuller et al. [21] and Chartrand et al. [5] independently proved that every graph in $\mathcal{G}_{\beta,D}$ has at most $D^\beta + \beta$ vertices. This bound is tight only for $D \leq 3$ or $\beta = 1$.

Our second contribution is to determine the (exact) maximum order of a graph in $\mathcal{G}_{\beta,D}$ for all values of D and β . This result is stated and proved in Section 3.

2 Graphs with Minimum Order

In this section we characterise the graphs in $\mathcal{G}_{\beta,D}$ with minimum order. We start with an elementary lemma.

Lemma 2.1. *Let S be a set of vertices in a connected graph G . Then $V(G) \setminus S$ resolves G if and only if every pair of vertices in S is resolved by some vertex not in S .*

Proof. If $v \in V(G) \setminus S$ and w is any other vertex, then v resolves v and w . By assumption every pair of vertices in S is resolved by some vertex in $V(G) \setminus S$. \square

Lemma 2.1 enables the minimum order of a graph in $\mathcal{G}_{\beta,D}$ to be easily determined.

Lemma 2.2 ([5, 21, 42]). *The minimum order of a graph in $\mathcal{G}_{\beta,D}$ is $\beta + D$.*

Proof. First we prove that every graph $G \in \mathcal{G}_{\beta,D}$ has order at least $\beta + D$. Let v_0, v_D be vertices such that $\text{dist}(v_0, v_D) = D$. Let $P = (v_0, v_1, \dots, v_D)$ be a path of length D in G . Then v_0 resolves v_i, v_j for all distinct $i, j \in [1, D]$. Thus $V(G) \setminus \{v_1, \dots, v_D\}$ resolves G by Lemma 2.1. Hence $\beta \leq |V(G)| - D$ and $|V(G)| \geq \beta + D$.

It remains to construct a graph $G \in \mathcal{G}_{\beta,D}$ with order $\beta + D$. Let G be the ‘broom’ tree obtained by adding β leaves adjacent to one endpoint of the path on D vertices. Observe

that $|V(G)| = \beta + D$ and G has diameter D . It follows from Slater's formula [36] for the metric dimension of a tree³ that the β leaves adjacent to one endpoint of the path are a metric basis of G . Hence $G \in \mathcal{G}_{\beta,D}$. \square

2.1 Twin Vertices

The following definitions and lemmas about twin vertices are well known. Let u be a vertex of a graph G . The *open neighbourhood* of u is $N(u) := \{v \in V(G) : uv \in E(G)\}$, and the *closed neighbourhood* of u is $N[u] := N(u) \cup \{u\}$. Two distinct vertices u, v are *adjacent twins* if $N[u] = N[v]$, and *non-adjacent twins* if $N(u) = N(v)$. Observe that if u, v are adjacent twins then $uv \in E(G)$, and if u, v are non-adjacent twins then $uv \notin E(G)$; thus the names are justified⁴. If u, v are adjacent or non-adjacent twins, then u, v are *twins*. The next lemma follows from the definitions.

Lemma 2.3. *If u, v are twins in a connected graph G , then $\text{dist}(u, x) = \text{dist}(v, x)$ for every vertex $x \in V(G) \setminus \{u, v\}$.* \square

Corollary 2.4. *Suppose that u, v are twins in a connected graph G and S resolves G . Then u or v is in S . Moreover, if $u \in S$ and $v \notin S$, then $(S \setminus \{u\}) \cup \{v\}$ also resolves G .* \square

Lemma 2.5. *In a set S of three vertices in a graph, it is not possible that two vertices in S are adjacent twins, and two vertices in S are non-adjacent twins.*

Proof. Suppose on the contrary that u, v are adjacent twins and v, w are non-adjacent twins. Since u, v are twins and $v \not\sim w$, we have $u \not\sim w$. Similarly, since v, w are twins and $u \sim v$, we have $u \sim w$. This is the desired contradiction. \square

Lemma 2.6. *Let u, v, w be distinct vertices in a graph. If u, v are twins and v, w are twins, then u, w are also twins.*

Proof. Suppose that u, v are adjacent twins. That is, $N[u] = N[v]$. By Lemma 2.5, v, w are adjacent twins. That is, $N[v] = N[w]$. Hence $N[u] = N[w]$. That is, u, w are adjacent twins. By a similar argument, if u, v are non-adjacent twins, then v, w are non-adjacent twins and u, w are non-adjacent twins. \square

For a graph G , a set $T \subseteq V(G)$ is a *twin-set* of G if v, w are twins in G for every pair of distinct vertices $v, w \in T$.

Lemma 2.7. *If T is a twin-set of a graph G , then either every pair of vertices in T are adjacent twins, or every pair of vertices in T are non-adjacent twins.*

³Also see [5, 16, 21] for proofs of Slater's formula.

⁴In the literature, adjacent twins are called *true* twins, and non-adjacent twins are called *false* twins. We prefer the more descriptive names, *adjacent* and *non-adjacent*.

Proof. Suppose on the contrary that some pair of vertices $v, w \in T$ are adjacent twins, and some pair of vertices $x, y \in T$ are non-adjacent twins. Thus v, w, x, y are distinct vertices by Lemma 2.5. If v, x are adjacent twins then $\{v, x, y\}$ contradict Lemma 2.5. Otherwise v, x are non-adjacent twins, in which case $\{v, w, x\}$ contradict Lemma 2.5. \square

Twin sets are important in the study of metric dimension because of the following lemma.

Lemma 2.8. *Let T be a twin-set of a connected graph G with $|T| \geq 3$. Then $\beta(G) = \beta(G \setminus u) + 1$ for every vertex $u \in T$.*

Proof. Let u, v, w be distinct vertices in T . By Corollary 2.4, there is a metric basis W of G such that $u, v \in W$. Since u has a twin in $G \setminus u$, for all $x, y \in V(G \setminus u)$ we have $\text{dist}_G(x, y) = \text{dist}_{G \setminus u}(x, y)$. In particular, $G \setminus u$ is connected. First we prove that $W \setminus \{u\}$ resolves $G \setminus u$. For all distinct vertices $x, y \in V(G \setminus u)$, there is a vertex $s \in W$ such that $\text{dist}_G(x, s) \neq \text{dist}_G(y, s)$. If $s \neq u$, then $s \in W \setminus \{u\}$ resolves the pair x, y . Otherwise, v is a twin of $s = u$ and $\text{dist}_{G \setminus u}(x, v) = \text{dist}_G(x, v) = \text{dist}_G(x, s) \neq \text{dist}_G(y, s) = \text{dist}_G(y, v) = \text{dist}_{G \setminus u}(y, v)$. Consequently, $v \in W \setminus \{u\}$ resolves the pair x, y . Now suppose that W' is a resolving set of $G \setminus u$ such that $|W'| < |W| - 1$. For all $x, y \in V(G \setminus u)$, there exists a vertex $s \in W'$ such that $\text{dist}_{G \setminus u}(x, s) \neq \text{dist}_{G \setminus u}(y, s)$. Then $W' \cup \{u\}$ is a resolving set in G of cardinality less than $|W|$, which contradicts the fact that W is a resolving set of minimum cardinality. \square

Note that it is necessary to assume that $|T| \geq 3$ in Lemma 2.8. For example, $\{x, z\}$ is a twin-set of the 3-vertex path $P_3 = (x, y, z)$, but $\beta(P_3) = \beta(P_3 \setminus x) = 1$.

Corollary 2.9. *Let T be a twin-set of a connected graph G with $|T| \geq 3$. Then $\beta(G) = \beta(G \setminus S) + |S|$ for every subset $S \subset T$ with $|S| \leq |T| - 2$.* \square

2.2 The Twin Graph

Let G be a graph. Define a relation \equiv on $V(G)$ by $u \equiv v$ if and only if $u = v$ or u, v are twins. By Lemma 2.6, \equiv is an equivalence relation. For each vertex $v \in V(G)$, let v^* be the set of vertices of G that are equivalent to v under \equiv . Let $\{v_1^*, \dots, v_k^*\}$ be the partition of $V(G)$ induced by \equiv , where each v_i is a representative of the set v_i^* . The *twin graph* of G , denoted by G^* , is the graph with vertex set $V(G^*) := \{v_1^*, \dots, v_k^*\}$, where $v_i^* v_j^* \in E(G^*)$ if and only if $v_i v_j \in E(G)$. The next lemma implies that this definition is independent of the choice of representatives.

Lemma 2.10. *Let G^* be the twin graph of a graph G . Then two vertices v^* and w^* of G^* are adjacent if and only if every vertex in v^* is adjacent to every vertex in w^* in G .*

Proof. If every vertex in v^* is adjacent to every vertex in w^* in G , then $v^* w^* \in E(G^*)$ by definition. For the converse, suppose that $v^* w^* \in E(G^*)$. Then some $v \in v^*$ is adjacent to some $w \in w^*$. Let $r \neq v$ be any vertex in v^* , and let $s \neq w$ be any vertex in w^* . Since v and r are twins, $rw \in E(G)$ and $rs \in E(G)$. Since w and s are twins, $sv \in E(G)$ and $sr \in E(G)$. That is, every vertex in v^* is adjacent to every vertex in w^* in G . \square

Let N_r denote the *null* graph with r vertices and no edges.

Each vertex v^* of G^* is a maximal twin-set of G . By Lemma 2.7, $G[v^*]$ is a complete graph if the vertices of v^* are adjacent twins, or $G[v^*]$ is a null graph if the vertices of v^* are non-adjacent twins. So it makes sense to consider the following types of vertices in G^* . We say that $v^* \in V(G^*)$ is of *type*:

- (1) if $|v^*| = 1$,
- (K) if $G[v^*] \cong K_r$ and $r \geq 2$,
- (N) if $G[v^*] \cong N_r$ and $r \geq 2$.

A vertex of G^* is of *type* (1K) if it is of type (1) or (K). A vertex of G^* is of *type* (1N) if it is of type (1) or (N). A vertex of G^* is of *type* (KN) if it is of type (K) or (N).

Observe that the graph G is uniquely determined by G^* , and the type and cardinality of each vertex of G^* . In particular, if v^* is adjacent to w^* in G^* , then every vertex in v^* is adjacent to every vertex in w^* in G .

We now show that the diameters of G and G^* are closely related.

Lemma 2.11. *Let $G \neq K_1$ be a connected graph. Then $\text{diam}(G^*) \leq \text{diam}(G)$. Moreover, $\text{diam}(G^*) < \text{diam}(G)$ if and only if $G^* \cong K_n$ for some $n \geq 1$. In particular, if $\text{diam}(G) \geq 3$ then $\text{diam}(G) = \text{diam}(G^*)$.*

Proof. If v, w are adjacent twins in G , then $\text{dist}_G(v, w) = 1$ and $v^* = w^*$. If v, w are non-adjacent twins in G , then (since G has no isolated vertices) $\text{dist}_G(v, w) = 2$ and $v^* = w^*$. If v, w are not twins, then there is a shortest path between v and w that contains no pair of twins (otherwise there is a shorter path); thus

$$\text{dist}_G(v, w) = \text{dist}_{G^*}(v^*, w^*). \tag{1}$$

This implies that $\text{diam}(G^*) \leq \text{diam}(G)$. Moreover, if $\text{ecc}_G(v) \geq 3$ then v is not a twin of every vertex w for which $\text{dist}_G(v, w) = \text{ecc}_G(v)$; thus $\text{dist}_G(v, w) = \text{dist}_{G^*}(v^*, w^*)$ by Equation (1) and $\text{ecc}_G(v) = \text{ecc}_{G^*}(v^*)$. Hence if $\text{diam}(G) \geq 3$ then $\text{diam}(G) = \text{diam}(G^*)$.

Now suppose that $\text{diam}(G) > \text{diam}(G^*)$. Thus $\text{diam}(G) \leq 2$. If $\text{diam}(G) = 1$ then G is a complete graph and $G^* \cong K_1$, as claimed. Otherwise $\text{diam}(G) = 2$ and $\text{diam}(G^*) \leq 1$; thus $G^* \cong K_n$ for some $n \geq 1$, as claimed.

It remains to prove that $\text{diam}(G^*) < \text{diam}(G)$ whenever $G^* \cong K_n$. In this case, $\text{diam}(G^*) \leq 1$. So we are done if $\text{diam}(G) \geq 2$. Otherwise $\text{diam}(G) \leq 1$ and G is also a complete graph. Thus $G^* \cong K_1$ and $\text{diam}(G^*) = 0$. Since $G \neq K_1$, we have $\text{diam}(G) = 1 > 0 = \text{diam}(G^*)$, as desired. \square

Note that graphs with $\text{diam}(G^*) < \text{diam}(G)$ include the complete multipartite graphs.

Theorem 2.14 below characterises the graphs in $\mathcal{G}_{\beta, D}$ for $D \geq 3$ in terms of the twin graph. Chartrand et al. [5] characterised⁵ the graphs in $\mathcal{G}_{\beta, D}$ for $D \leq 2$. For consistency

⁵To be more precise, Chartrand et al. [5] characterised the graphs with $\beta(G) = n - 2$. By Lemma 2.2, if $\beta(G) = n - 2$ then G has diameter at most 2. By Proposition 2.12, if G has diameter 1 then $\beta(G) = n - 1$. Thus if $\beta(G) = n - 2$ then G has diameter 2.

with Theorem 2.14, we describe the characterisation by Chartrand et al. [5] in terms of the twin graph.

Proposition 2.12 ([5]). *The following are equivalent for a connected graph G with $n \geq 2$ vertices:*

- G has metric dimension $\beta(G) = n - 1$,
- $G \cong K_n$,
- $\text{diam}(G) = 1$,
- the twin graph G^* has one vertex, which is of type (K) .

Proposition 2.13 ([5]). *The following are equivalent for a connected graph G with $n \geq 3$ vertices:*

- G has metric dimension $\beta(G) = n - 2$,
- G has metric dimension $\beta(G) = n - 2$ and diameter $\text{diam}(G) = 2$,
- the twin graph G^* of G satisfies
 - $G^* \cong P_2$ with at least one vertex of type (N) , or
 - $G^* \cong P_3$ with one leaf of type (1) , the other leaf of type $(1K)$, and the degree-2 vertex of type $(1K)$.

To describe our characterisation we introduce the following notation. Let $P_{D+1} = (u_0, u_1, \dots, u_D)$ be a path of length D . As illustrated in Figure 1(a), for $k \in [3, D - 1]$ let $P_{D+1,k}$ be the graph obtained from P_{D+1} by adding one vertex adjacent to u_{k-1} . As illustrated in Figure 1(b), for $k \in [2, D - 1]$ let $P'_{D+1,k}$ be the graph obtained from P_{D+1} by adding one vertex adjacent to u_{k-1} and u_k .

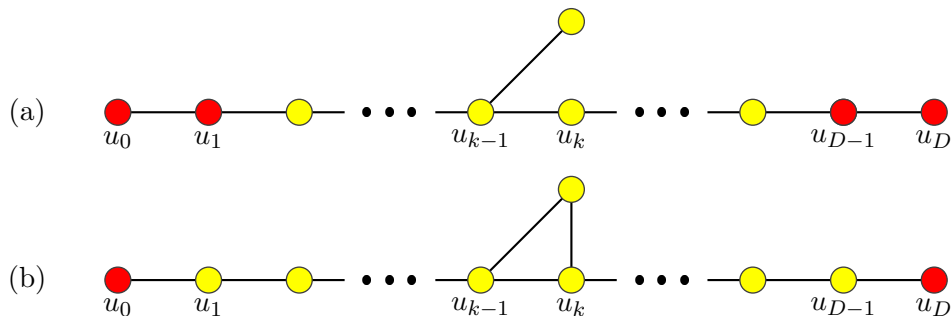

Figure 1: The graphs (a) $P_{D+1,k}$ and (b) $P'_{D+1,k}$.

Theorem 2.14. *Let G be a connected graph of order n and diameter $D \geq 3$. Let G^* be the twin graph of G . Let $\alpha(G^*)$ be the number of vertices of G^* of type (K) or (N) . Then $\beta(G) = n - D$ if and only if G^* is one of the following graphs:*

1. $G^* \cong P_{D+1}$ and one of the following cases holds (see Figure 2):
 - (a) $\alpha(G^*) \leq 1$;
 - (b) $\alpha(G^*) = 2$, the two vertices of G^* not of type (1) are adjacent, and if one is a leaf of type (K) then the other is also of type (K) ;
 - (c) $\alpha(G^*) = 2$, the two vertices of G^* not of type (1) are at distance 2 and both are of type (N) ; or
 - (d) $\alpha(G^*) = 3$ and there is a vertex of type (N) or (K) adjacent to two vertices of type (N) .
2. $G^* \cong P_{D+1,k}$ for some $k \in [3, D-1]$, the degree-3 vertex u_{k-1}^* of G^* is any type, each neighbour of u_{k-1}^* is type $(1N)$, and every other vertex is type (1); see Figure 3.
3. $G^* \cong P'_{D+1,k}$ for some $k \in [2, D-1]$, the three vertices in the cycle are of type $(1K)$, and every other vertex is of type (1); see Figure 4.

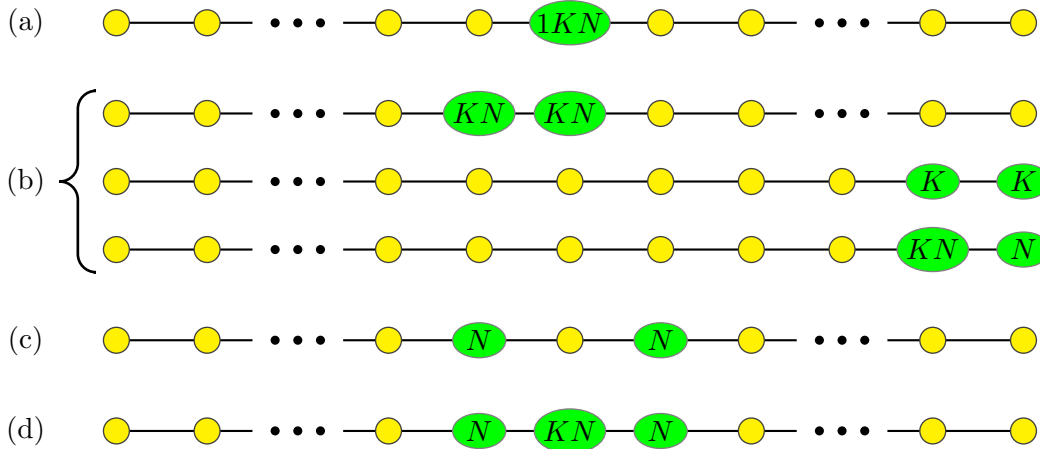

Figure 2: Cases (a)–(d) with $G^* \cong P_{D+1}$ in Theorem 2.14.

2.3 Proof of Necessity

Throughout this section, G is a connected graph of order n , diameter $D \geq 3$, and metric dimension $\beta(G) = n - D$. Let G^* be the twin graph of G .

Lemma 2.15. *There exists a vertex u_0 in G of eccentricity D with no twin.*

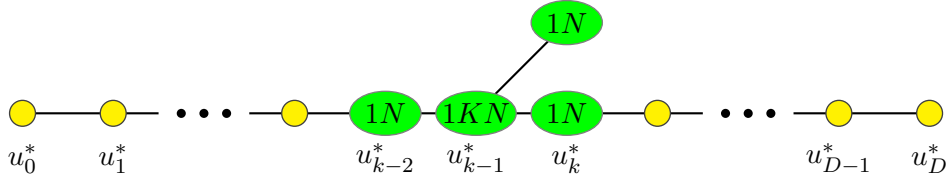

Figure 3: The case of $G^* \cong P_{D+1,k}$ in Theorem 2.14.

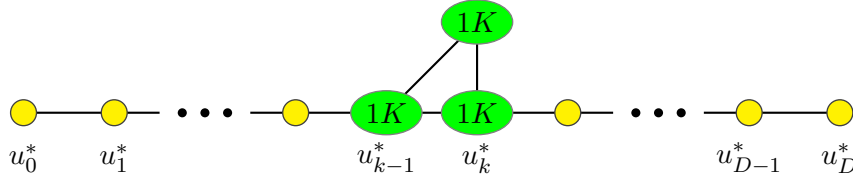

Figure 4: The case of $G^* \cong P'_{D+1,k}$ in Theorem 2.14.

Proof. Let u_0 and u_D be vertices at distance D in G . As illustrated in Figure 5, let (u_0, u_1, \dots, u_D) be a shortest path between u_0 and u_D . Suppose on the contrary that both u_0 and u_D have twins. Let x be a twin of u_0 and y be a twin of u_D . We claim that $\{x, y\}$ resolves $\{u_0, \dots, u_D\}$. Now $u_0 \not\sim u_i$ for all $i \in [2, D]$, and thus $x \not\sim u_i$ (since x, u_0 are twins). Thus $\text{dist}(x, u_i) = i$ for each $i \in [1, D]$. Hence x resolves u_i, u_j for all distinct $i, j \in [1, D]$. By symmetry, $\text{dist}(y, u_i) = D - i$ for all $i \in [0, D - 1]$, and y resolves u_i, u_j for all distinct $i, j \in [0, D - 1]$. Thus $\{x, y\}$ resolves $\{u_0, \dots, u_D\}$, except for possibly the pair u_0, u_D . Now $\text{dist}(x, u_0) \leq 2$ and $\text{dist}(x, u_D) = D$. Since $D \geq 3$, x resolves u_0, u_D . Thus $\{x, y\}$ resolves $\{u_0, \dots, u_D\}$. By Lemma 2.1, $\beta(G) \leq n - (D + 1) < n - D$, which is a contradiction. Thus u_0 or u_D has no twin. \square

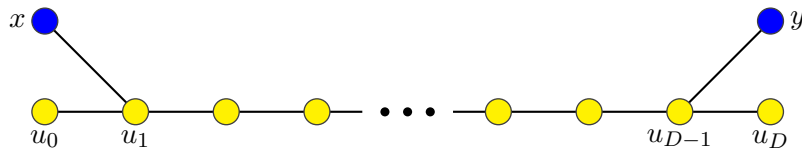

Figure 5: $\{x, y\}$ resolves $\{u_0, \dots, u_D\}$ in Lemma 2.15.

For the rest of the proof, fix a vertex u_0 of eccentricity D in G with no twin, which exists by Lemma 2.15. Thus $u_0^* = \{u_0\}$ and $\text{ecc}_{G^*}(u_0^*) = \text{ecc}_G(u_0) = D$, which is also the diameter of G^* by Lemma 2.11. As illustrated in Figure 6, for each $i \in [0, D]$, let

$$A_i^* := \{v^* \in V(G^*) : \text{dist}(u_0^*, v^*) = i\}, \text{ and}$$

$$A_i := \{v \in V(G) : \text{dist}(u_0, v) = i\} = \bigcup \{v^* : v^* \in A_i^*\}.$$

Note that the last equality is true because u_0 has no twin and $\text{dist}(u_0, v) = \text{dist}(u_0, w)$ if v, w are twins. For all $i \in [0, D]$, we have $|A_i| \geq 1$ and $|A_i^*| \geq 1$. Moreover, $|A_0| = |A_0^*| = 1$. Let (u_0, u_1, \dots, u_D) be a path in G such that $u_i \in A_i$ for each $i \in [0, D]$. Observe that if $v \in A_i$ is adjacent to $w \in A_j$ then $|i - j| \leq 1$. In particular, $(u_i, u_{i+1}, \dots, u_j)$ is a shortest path between u_i and u_j .

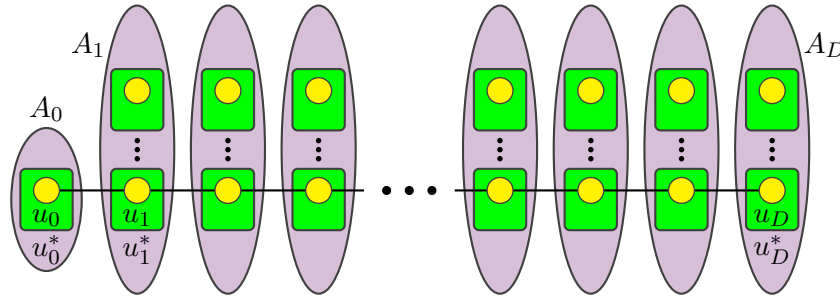

Figure 6: The sets A_0, A_1, \dots, A_D .

Lemma 2.16. For each $k \in [1, D]$,

- $G[A_k]$ is a complete graph or a null graph;
- $G^*[A_k^*]$ is a complete graph or a null graph, and all the vertices in A_k^* are of type (1K) in the first case, and of type (1N) in the second case.

Proof. Suppose that $G[A_k]$ is neither complete nor null for some $k \in [1, D]$. Thus there exist vertices $u, v, w \in A_k$ such that $u \sim v \not\sim w$, as illustrated in Figure 7⁶. Let $S := (\{u_1, \dots, u_D\} \setminus \{u_k\}) \cup \{u, w\}$. Every pair of vertices in S is resolved by u_0 , except for u, w , which is resolved by v . Thus $\{u_0, v\}$ resolves S . By Lemma 2.1, $\beta(G) \leq n - (D + 1) < n - D$. This contradiction proves the first claim, which immediately implies the second claim. \square

Lemma 2.17. For each $k \in [1, D]$, if $|A_k| \geq 2$ then

- (a) $v \sim w$ for all vertices $v \in A_{k-1}$ and $w \in A_k$;
- (b) $v^* \sim w^*$ for all vertices $v^* \in A_{k-1}^*$ and $w^* \in A_k^*$.

Proof. First we prove (a). Every vertex in A_1 is adjacent to u_0 , which is the only vertex in A_0 . Thus (a) is true for $k = 1$. Now assume that $k \geq 2$. Suppose on the contrary that $v \not\sim w$ for some $v \in A_{k-1}$ and $w \in A_k$. There exists a vertex $u \in A_{k-1}$ adjacent to w . As illustrated in Figure 8, if $w \neq u_k$ then $\{u_0, w\}$ resolves $(\{u_1, \dots, u_D\} \setminus \{u_{k-1}\}) \cup \{u, v\}$.

⁶In Figures 7–22, a solid line connects adjacent vertices, a dashed line connects non-adjacent vertices, and a coil connects vertices that may or may not be adjacent.

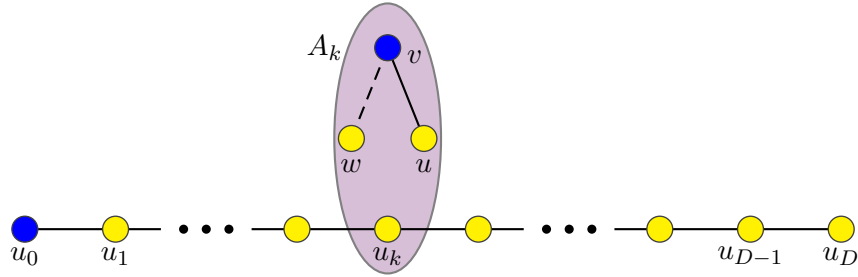

Figure 7: $\{u_0, v\}$ resolves $(\{u_1, \dots, u_D\} \setminus \{u_k\}) \cup \{u, w\}$ in Lemma 2.16.

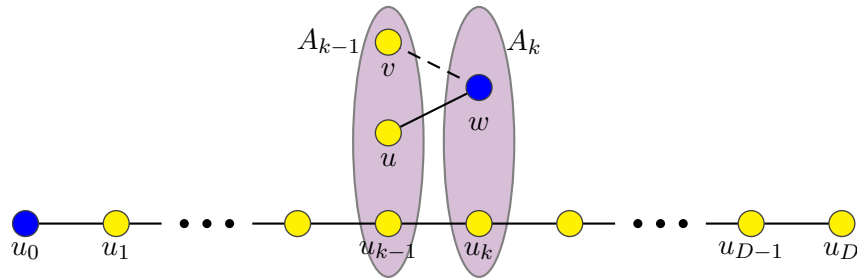

Figure 8: In Lemma 2.17, $\{u_0, w\}$ resolves $(\{u_1, \dots, u_D\} \setminus \{u_{k-1}\}) \cup \{u, v\}$.

As illustrated in Figure 9, if $w = u_k$ then $v \neq u_{k-1}$ and there exists a vertex $z \neq u_k$ in A_k , implying $\{u_0, u_k\}$ resolves $(\{u_1, \dots, u_D\} \setminus \{u_k\}) \cup \{v, z\}$. In both cases, Lemma 2.1 implies that $\beta(G) \leq n - D - 1$. This contradiction proves (a), which immediately implies (b). \square

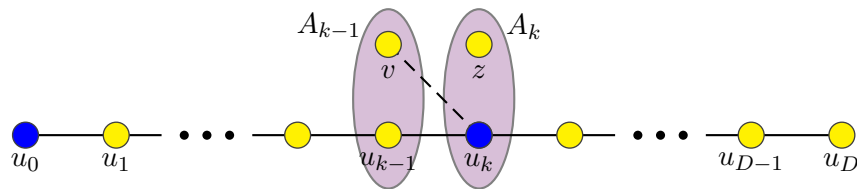

Figure 9: In Lemma 2.17, $\{u_0, u_k\}$ resolves $(\{u_1, \dots, u_D\} \setminus \{u_k\}) \cup \{v, z\}$.

Lemma 2.18. *If $|A_i| \geq 2$ and $|A_j| \geq 2$ then $|i - j| \leq 2$. Thus there are at most three distinct subsets A_i, A_j, A_k each with cardinality at least 2.*

Proof. Suppose on the contrary that $|A_i| \geq 2$ and $|A_j| \geq 2$ for some $i, j \in [1, D]$ with $j \geq i + 3$, as illustrated in Figure 10. Let $x \neq u_i$ be a vertex in A_i . Let $y \neq u_j$ be a vertex in A_j . We claim that $\{u_j, x\}$ resolves $(\{u_0, \dots, u_D\} \setminus \{u_j\}) \cup \{y\}$.

By Lemma 2.17, $u_{i-1} \sim x$ and $u_{j-1} \sim y$. Observe that $\text{dist}(u_j, y) \in \{1, 2\}$; $\text{dist}(u_j, u_{j-h}) = h$ for all $h \in [1, j]$; $\text{dist}(u_j, u_{j+h}) = h$ for all $h \in [1, D-j]$. Thus u_j resolves $(\{u_0, \dots, u_D\} \setminus \{u_j\}) \cup \{y\}$, except for the following pairs:

- u_{j-h}, u_{j+h} whenever $1 \leq h \leq j \leq D-h$;
- y, u_{j-1} and y, u_{j+1} if $\text{dist}(y, u_j) = 1$; and
- y, u_{j-2} and y, u_{j+2} if $\text{dist}(y, u_j) = 2$.

We claim that x resolves each of these pairs. By Lemma 2.17, there is a shortest path between x and u_{j-1} that passes through u_{j-2} . Let $r := \text{dist}(x, u_{j-2})$. Thus $\text{dist}(x, u_{j-1}) = r+1$, $\text{dist}(x, u_j) = r+2$, $\text{dist}(x, u_{j+1}) = r+3$, and $\text{dist}(x, u_{j+h}) = r+4$. Thus x resolves every pair of vertices in $\{u_{j-2}, u_{j-1}, y, u_{j+1}, u_{j+2}\}$. It remains to prove that x resolves u_{j-h}, u_{j+h} whenever $3 \leq h \leq j \leq D-h$. Observe that $\text{dist}(x, u_{j+h}) \geq j+h-i$. If $j-h \geq i$ then, since $(x, u_{i-1}, \dots, u_{j-h})$ is a path,

$$\text{dist}(x, u_{j-h}) \leq j-h-i+2 < j+h-i \leq \text{dist}(x, u_{j+h}).$$

Otherwise $j-h \leq i-1$, implying

$$\text{dist}(x, u_{j-h}) = i - (j-h) < j+h-i \leq \text{dist}(x, u_{j+h}).$$

In each case $\text{dist}(x, u_{j-h}) < \text{dist}(x, u_{j+h})$. Thus x resolves u_{j-h}, u_{j+h} .

Hence $\{u_j, x\}$ resolves $(\{u_0, \dots, u_D\} \setminus \{u_j\}) \cup \{y\}$. By Lemma 2.1, $\beta(G) \leq n - D - 1$ which is the desired contradiction. \square

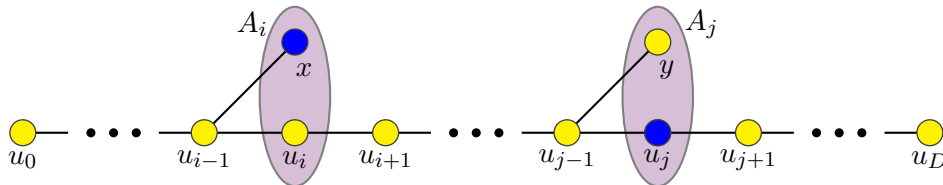

Figure 10: $\{u_j, x\}$ resolves $(\{u_0, \dots, u_D\} \setminus \{u_j\}) \cup \{y\}$ in Lemma 2.18.

Lemma 2.19. $|A_1^*| = 1$ and $|A_D^*| = 1$.

Proof. Consider a vertex $v \in A_1$. Then $v \sim u_0$ and every other neighbour of v is in $A_1 \cup A_2$. By Lemma 2.16, $G[A_1]$ is complete or null. If every vertex in A_1 is adjacent to every vertex in A_2 , then A_1 is a twin-set, and $|A_1^*| = 1$ as desired.

Now assume that some vertex $v \in A_1$ is not adjacent to some vertex in A_2 . By Lemma 2.17, the only vertex in A_2 is u_2 , and $v \not\sim u_2$. If $G[A_1]$ is null then $\text{ecc}(v) > D$, and if $G[A_1]$ is complete then v and u_0 are twins. In both cases we have a contradiction.

If $|A_D| = 1$ then $|A_D^*| = 1$. Now assume that $|A_D| \geq 2$. The neighbourhood of every vertex in A_D is contained in $A_{D-1} \cup A_D$. By Lemma 2.17, every vertex in A_D is adjacent to every vertex in A_{D-1} . By Lemma 2.16, $G[A_D]$ is complete or null. Thus A_D is a twin-set, implying $|A_D^*| = 1$. \square

Lemma 2.20. For each $k \in [1, D - 1]$, distinct vertices $v, w \in A_k$ are twins if and only if they have the same neighbourhood in A_{k+1} .

Proof. The neighbourhood of both v and w is contained in $A_{k-1} \cup A_k \cup A_{k+1}$. By Lemma 2.17, both v and w are adjacent to every vertex in A_{k-1} . By Lemma 2.16, $G[A_k]$ is complete or null. Thus v and w are twins if and only if they have the same neighbourhood in A_{k+1} . \square

Lemma 2.21. For each $k \in [2, D]$,

- (a) if $|A_k| \geq 2$ then $|A_{k-1}^*| = 1$;
- (b) if $|A_k| = 1$ then $|A_{k-1}^*| \leq 2$.

Proof. Suppose that $|A_k| \geq 2$. If $|A_{k-1}| = 1$ then $|A_{k-1}^*| = 1$ as desired. Now assume that $|A_{k-1}| \geq 2$. Thus A_{k-1} is a twin-set by Lemmas 2.17 and 2.20, implying $|A_{k-1}^*| = 1$. Now suppose that $|A_k| = 1$. If $|A_{k-1}| = 1$ then $|A_{k-1}^*| = 1$ and we are done. So assume that $|A_{k-1}| \geq 2$. By Lemma 2.20, the set of vertices in A_{k-1} that are adjacent to the unique vertex in A_k is a maximal twin-set, and the set of vertices in A_{k-1} that are not adjacent to the unique vertex in A_k is a maximal twin-set (if it is not empty). Therefore $|A_{k-1}^*| \leq 2$. \square

Lemma 2.22. For each $k \in [1, D]$, we have $|A_k^*| \leq 2$. Moreover, there are at most three values of k for which $|A_k^*| = 2$. Furthermore, if $|A_i^*| = 2$ and $|A_j^*| = 2$ then $|i - j| \leq 2$.

Proof. Lemma 2.19 proves the result for $k = D$. Now assume that $k \in [1, D - 1]$. Suppose on the contrary that $|A_k^*| \geq 3$ for some $k \in [1, D]$. By the contrapositive of Lemma 2.21(a), $|A_{k+1}| = 1$. By Lemma 2.21(b), $|A_k^*| \leq 2$, which is the desired contradiction. The remaining claims follow immediately from Lemma 2.18. \square

Lemma 2.23. Suppose that $|A_k^*| = 2$ for some $k \in [2, D - 1]$. Then $|A_{k+1}| = |A_{k+1}^*| = 1$, and exactly one of the two vertices of A_k^* is adjacent to the only vertex of A_{k+1}^* . Moreover, if $k \leq D - 2$ then $|A_{k+2}| = |A_{k+2}^*| = 1$.

Proof. By the contrapositive of Lemma 2.21(a), $|A_{k+1}| = |A_{k+1}^*| = 1$. By Lemma 2.20, exactly one vertex in A_k^* is adjacent to the vertex in A_{k+1}^* . Now suppose that $k \leq D - 2$ but $|A_{k+2}| \geq 2$. As illustrated in Figure 11, let $x \neq u_{k+2}$ be a vertex in A_{k+2} . Let $y \neq u_k$ be a vertex in A_k , such that y, u_k are not twins, that is, $y \not\sim u_{k+1}$. By Lemma 2.17, $u_{k-1} \sim y$ and $u_{k+1} \sim x$. Thus $\{x, u_0\}$ resolves $\{u_1, \dots, u_D, y\}$. By Lemma 2.1, $\beta(G) \leq n - D - 1$, which is a contradiction. Hence $|A_{k+2}| = 1$, implying $|A_{k+2}^*| = 1$. \square

We now prove that the structure of the graph G^* is as claimed in Theorem 2.14.

Lemma 2.24. Either $G^* \cong P_{D+1}$, $G^* \cong P_{D+1,k}$ for some $k \in [3, D - 1]$, or $G^* \cong P'_{D+1,k}$ for some $k \in [2, D - 1]$.

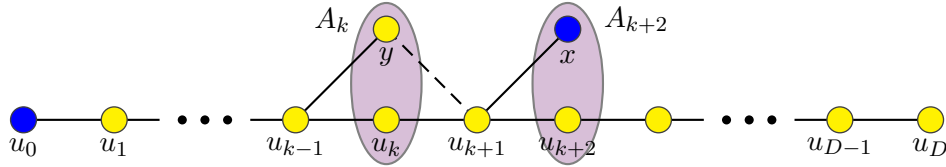

Figure 11: $\{x, u_0\}$ resolves $\{u_1, \dots, u_D, y\}$ in Lemma 2.23.

Proof. By Lemma 2.22 each set A_k^* contains at most two vertices of G^* . Lemmas 2.19, 2.18 and 2.23 imply that $|A_k^*| = 2$ for at most one $k \in [0, D]$. If $|A_k^*| = 1$ for every $k \in [0, D]$ then $G^* \cong P_{D+1}$ as desired.

Now assume that $|A_k^*| = 2$ for exactly one $k \in [0, D]$. By Lemma 2.19, $k \in [2, D - 1]$. Let w^* be the vertex in A_k^* besides u_k^* . Then $w^* \sim u_{k-1}^*$ by Lemma 2.17. If $w^* \sim u_k^*$ then $G^* \cong P'_{D+1,k}$. Otherwise $w^* \not\sim u_k^*$. Then $G^* \cong P_{D+1,k}$. It remains to prove that in this case $k \neq 2$.

Suppose on the contrary that $G^* \cong P_{D+1,k}$ and $k = 2$. Thus $|A_2^*| = 2$. Say $A_2^* = \{u_2^*, w^*\}$, where $u_2^* \not\sim w^*$. By Lemma 2.23, $|A_3^*| = 1$. Thus $A_3^* = \{u_3^*\}$. Since $u_2^* \sim u_3^*$, by Lemma 2.20, $w^* \not\sim u_3^*$. Thus u_1^* is the only neighbour of w^* . Hence every vertex in w^* is a twin of u_0 , which contradicts the fact that u_0 has no twin. Thus $k \neq 2$ if $G^* \cong P_{D+1,k}$. \square

We now prove restrictions about the type of vertices in G^* . To start with, Lemma 2.18 implies:

Corollary 2.25. *If $G^* \cong P_{D+1}$ then $\alpha(G^*) \leq 3$ and the distance between every pair of vertices not of type (1) is at most 2.*

Lemma 2.26. *Suppose that $G^* \cong P_{D+1}$ and $\alpha(G^*) = 2$. If the two vertices of G^* not of type (1) are adjacent, and one of them is a leaf of type (K), then the other is also of type (K).*

Proof. As illustrated in Figure 12, let x and y be twins of u_{D-1} and u_D respectively. By assumption $G[A_D]$ is a complete graph. Suppose on the contrary that $G[A_{D-1}]$ is a null graph. By Lemma 2.17, every vertex in A_D is adjacent to every vertex in A_{D-1} . Thus y resolves $\{u_0, \dots, u_D\}$, except for the pair u_{D-1}, u_D , which is resolved by x . Thus $\{x, y\}$ resolves $\{u_0, \dots, u_D\}$. By Lemma 2.1, $\beta(G) \leq n - D - 1$, which is a contradiction. Thus $G[A_{D-1}]$ is a complete graph. \square

Lemma 2.27. *Suppose that $G^* \cong P_{D+1}$ and for some $k \in [2, D - 1]$, the vertices u_{k-1}^* and u_{k+1}^* of G^* are both not of type (1). Then u_{k-1}^* and u_{k+1}^* are both of type (N).*

Proof. Let x and y be twins of u_{k-1} and u_{k+1} respectively. Suppose on the contrary that one of u_{k-1}^* and u_{k+1}^* is of type (K). Without loss of generality u_{k-1}^* is of type (K), as illustrated in Figure 13. Thus $u_{k-1} \sim x$. We claim that $\{x, y\}$ resolves $\{u_0, u_1, \dots, u_D\}$.

Observe that x resolves every pair of vertices of $\{u_0, u_1, \dots, u_D\}$ except for:

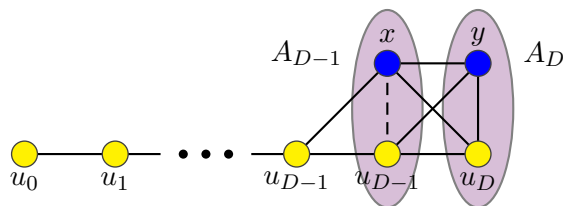

Figure 12: $\{x, y\}$ resolves $\{u_0, \dots, u_D\}$ in Lemma 2.26.

- each pair of vertices in $\{u_{k-2}, u_{k-1}, u_k\}$, which are all resolved by y since $d(y, u_k) = 1$, $d(y, u_{k-1}) = 2$, and $d(y, u_{k-2}) = 3$; and
- the pairs $\{u_{k-j}, u_{k+j-2} : j \in [3, \min\{k, D + 2 - k\}]\}$, which are all resolved by y since $d(y, u_{k-j}) = j + 1$, and

$$d(y, u_{k+j-2}) = \begin{cases} j - 2 & \text{if } j \geq 4, \\ 1 \text{ or } 2 & \text{if } j = 3. \end{cases}$$

Hence $\{x, y\}$ resolves $\{u_0, u_1, \dots, u_D\}$. Thus Lemma 2.1 implies $\beta(G) \leq n - D - 1$, which is the desired contradiction. Hence u_{k-1}^* and u_{k+1}^* are both of type (N). \square

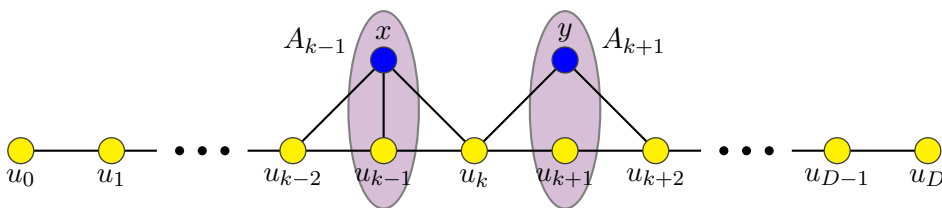

Figure 13: $\{x, y\}$ resolves $\{u_0, \dots, u_D\}$ in Lemma 2.27.

Corollary 2.25 and Lemmas 2.26 and 2.27 prove the necessity of the conditions in Theorem 2.14 when $G^* \cong P_{D+1}$.

Lemma 2.28. *Suppose that $G^* \cong P_{D+1,k}$ for some $k \in [3, D - 1]$, where $A_k^* = \{u_k^*, w^*\}$ and $w^* \sim u_{k-1}^*$. Then u_{k-2}^* , u_k^* and w^* are type (1N), u_{k-1}^* is any type, and every other vertex is type (1).*

Proof. Since $u_k^* \not\sim w^*$, Lemma 2.16 implies that u_k^* and w^* are both type (1N). By Lemmas 2.18 and 2.23, the remaining vertices are of type (1) except, possibly u_{k-2}^* and u_{k-1}^* . Suppose that u_{k-2}^* is of type (K), as illustrated in Figure 14. Let x be a twin of u_{k-1}^* . Then $x \sim u_{k-1}$. We claim that $\{x, w\}$ resolves $\{u_0, u_1, \dots, u_D\}$.

Observe that x resolves every pair of vertices in $\{u_0, u_1, \dots, u_D\}$ except for:

- each pair of vertices in $\{u_{k-3}, u_{k-2}, u_{k-1}\}$, which are all resolved by w since $d(w, u_{k-1}) = 1$, $d(w, u_{k-2}) = 2$, and $d(w, u_{k-3}) = 3$; and
- the pairs $\{u_{k-2-j}, u_{k-2+j} : j \in [2, \min\{k-2, D-k+2\}]\}$, which are all resolved by w since $d(w, u_{k-2-j}) = j+2$ and $d(w, u_{k-2+j}) = j$.

Thus $\{x, w\}$ resolves $\{u_0, u_1, \dots, u_D\}$. Hence Lemma 2.1 implies that $\beta(G) \leq n-D-1$, which is the desired contradiction. \square

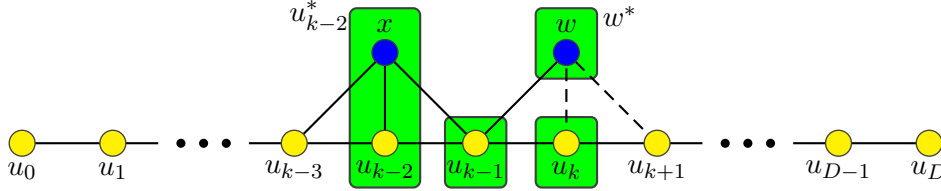

Figure 14: $\{x, w\}$ resolves $\{u_0, \dots, u_D\}$ in Lemma 2.28.

Lemma 2.29. *Suppose that $G^* \cong P'_{D+1,k}$ for some $k \in [2, D-1]$, where $A_k^* = \{u_k^*, w^*\}$ and $u_{k-1}^* \sim w^* \sim u_k^*$. Then u_{k-1}^* , u_k^* and w^* are type (1K), and every other vertex is type (1).*

Proof. Since $u_k^* \sim w^*$, Lemma 2.16 implies that u_k^* and w^* are type (1K). By Lemmas 2.18 and 2.23, the remaining vertices are type (1) except possibly u_{k-2}^* and u_{k-1}^* .

Suppose on the contrary that u_{k-2}^* is type (K) or (N), as illustrated in Figure 15. Let x be a twin of u_{k-2}^* . We claim that $\{x, w\}$ resolves $\{u_0, u_1, \dots, u_D\}$. Observe that w resolves every pair of vertices in $\{u_0, u_1, \dots, u_D\}$, except for pairs

$$\{u_{k-1-j}, u_{k+j} : j \in [0, \min\{k-1, D-k\}]\}.$$

These pairs are all resolved by x since $d(x, u_{k+j}) = j+2$ and

$$d(x, u_{k-1-j}) = \begin{cases} j-1 & \text{if } j \geq 2, \\ 1 \text{ or } 2 & \text{if } j = 1, \\ 1 & \text{if } j = 0. \end{cases}$$

Thus $\{x, w\}$ resolves $\{u_0, u_1, \dots, u_D\}$.

Suppose on the contrary that u_{k-1}^* is type (N), as illustrated in Figure 16. Let y be a twin of u_{k-1}^* . We claim that $\{y, w\}$ resolves $\{u_0, u_1, \dots, u_D\}$. Observe that w resolves every pair of vertices in $\{u_0, u_1, \dots, u_D\}$, except for pairs

$$\{u_{k-1-j}, u_{k+j} : j \in [0, \min\{k-1, D-k\}]\}.$$

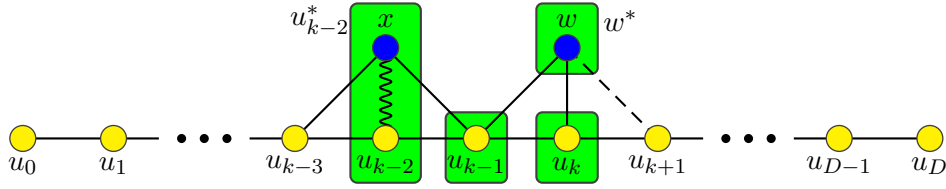

Figure 15: $\{x, w\}$ resolves $\{u_0, u_1, \dots, u_D\}$ in Lemma 2.29.

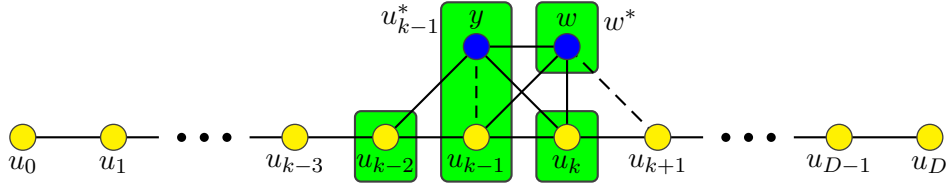

Figure 16: $\{y, w\}$ resolves $\{u_0, u_1, \dots, u_D\}$ in Lemma 2.29.

These pairs are all resolved by y since $d(y, u_{k+j}) = j + 1$ and

$$d(y, u_{k-1-j}) = \begin{cases} j & \text{if } j \geq 1, \\ 2 & \text{if } j = 0. \end{cases}$$

Thus $\{y, w\}$ resolves $\{u_0, u_1, \dots, u_D\}$.

By Lemma 2.1, in each case $\beta(G) \leq n - D - 1$, which is the desired contradiction. \square

Observe that Lemmas 2.28 and 2.29 imply the necessity of the conditions in Theorem 2.14 when $G^* \cong P_{D+1,k}$ or $G^* \cong P'_{D+1,k}$. This completes the proof of the necessity of the conditions in Theorem 2.14.

2.4 Proof of Sufficiency

Let G be a graph with n vertices and $\text{diam}(G) \geq 3$. Let T be a twin-set of cardinality $r \geq 3$ in G . Let G' be the graph obtained from G by deleting all but two of the vertices in T . As in Lemma 2.11, $\text{diam}(G') = \text{diam}(G)$. Say G' has order n' . Then by Corollary 2.9, $\beta(G') = \beta(G) - (r - 2)$. Since $n' = n - (r - 2)$, we have that $\beta(G) = n - D$ if and only if $\beta(G') = n' - D$. Thus it suffices to prove the sufficiency in Theorem 2.14 for graphs G whose maximal twin-sets have at most two vertices. We assume in the remainder of this section that every twin-set in G has at most two vertices.

Suppose that the twin graph G^* of G is one of the graphs stated in Theorem 2.14. We need to prove that $\beta(G) = n - D$. Since $\beta(G) \leq n - D$ by Lemma 2.2, it suffices to prove that every subset of $n - D - 1$ vertices of G is not a resolving set. By Corollary 2.4, every resolving set contains at least one vertex in each twin-set of cardinality 2. Observe also that, since $\alpha(G^*)$ is the number of vertices of G^* not of type (1), we have that $\alpha(G^*) = n - |V(G^*)|$.

Case 1. $G^* \cong P_{D+1}$ with vertices $u_0^* \sim u_1^* \sim \dots \sim u_D^*$: We now prove that for each subcase stated in Theorem 2.14 every set of $n - D - 1 = n - |V(G^*)| = \alpha(G^*)$ vertices of G does not resolve G . Suppose on the contrary that W is a resolving set of G of cardinality $\alpha(G^*)$.

Case 1(a). $\alpha(G^*) \leq 1$: We need at least one vertex to resolve a graph G of order $n \geq 2$. So $\alpha(G^*) = 1$. Thus G is not a path, but Khuller et al. [21] and Chartrand et al. [5] independently proved that every graph with metric dimension 1 is a path, which is a contradiction.

Case 1(b)(i). $\alpha(G^*) = 2$, and u_k^*, u_{k+1}^* are not of type (1) for some $k \in [1, D - 2]$: As illustrated in Figure 17, consider vertices $x \neq u_k$ in u_k^* , and $y \neq u_{k+1}$ in u_{k+1}^* . By Corollary 2.4, we may assume that $W = \{x, y\}$.

Suppose that u_k^* is type (N). Then $x \not\sim u_k$, implying $\text{dist}(x, u_k) = \text{dist}(x, u_{k+2}) = 2$ and $\text{dist}(y, u_k) = \text{dist}(y, u_{k+2}) = 1$. Thus neither x nor y resolves u_k, u_{k+2} .

Suppose that u_{k+1}^* is type (N). Then $y \not\sim u_{k+1}$, implying $\text{dist}(x, u_{k-1}) = \text{dist}(x, u_{k+1}) = 1$ and $\text{dist}(y, u_{k-1}) = \text{dist}(y, u_{k+1}) = 2$. Thus neither x nor y resolves u_{k-1}, u_{k+1} .

Suppose that u_k^* and u_{k+1}^* are both type (K). Then $x \sim u_k$ and $y \sim u_{k+1}$, implying $\text{dist}(x, u_k) = \text{dist}(x, u_{k+1}) = 1$ and $\text{dist}(y, u_k) = \text{dist}(y, u_{k+1}) = 1$. Thus neither x nor y resolves u_k, u_{k+1} .

In each case we have a contradiction.

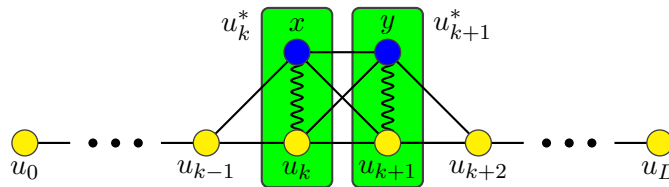

Figure 17: In Case 1(b)(i).

Case 1(b)(ii). $\alpha(G^*) = 2$, u_{D-1}^* is not type (1), and u_D^* is not type (1): As illustrated in Figure 18, consider $x \neq u_{D-1}$ in u_{D-1}^* and $y \neq u_D$ in u_D^* . By Corollary 2.4, we may assume that $W = \{x, y\}$.

First suppose that u_D^* is of type (N). Then $y \not\sim u_D$, implying $\text{dist}(x, u_{D-2}) = \text{dist}(x, u_D) = 1$ and $\text{dist}(y, u_{D-2}) = \text{dist}(y, u_D) = 2$. Thus neither x nor y resolves u_{D-2}, u_D , which is a contradiction.

Suppose that u_D^* and u_{D-1}^* are both type (K). Then $x \sim u_{D-1}$ and $y \sim u_D$, implying $\text{dist}(x, u_{D-1}) = \text{dist}(x, u_D) = 1$ and $\text{dist}(y, u_{D-1}) = \text{dist}(y, u_D) = 1$. Thus neither x nor y resolves u_{D-1}, u_D , which is a contradiction.

Case 1(c). $\alpha(G^*) = 2$ and u_{k-1}^* is type (N), and u_{k+1}^* is type (N) for some $k \in [2, D - 1]$: As illustrated in Figure 19, consider $x \neq u_{k-1}$ in u_{k-1}^* and $y \neq u_{k+1}$ in u_{k+1}^* . By Corollary 2.4, we may assume that $W = \{x, y\}$. Since $x \not\sim u_{k-1}$ and $y \not\sim u_{k+1}$, we have $\text{dist}(x, u_{k-1}) = \text{dist}(x, u_{k+1}) = 2$ and $\text{dist}(y, u_{k-1}) = \text{dist}(y, u_{k+1}) = 2$. Thus neither x nor y resolves u_{k-1}, u_{k+1} , which is a contradiction.

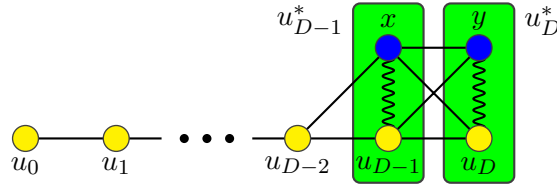

Figure 18: In Case 1(b)(ii).

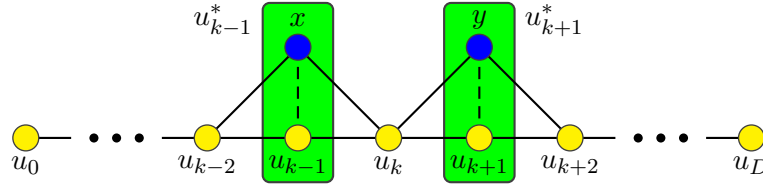

Figure 19: $\{x, y\}$ does not resolve u_{k-1}, u_{k+1} in Case 1(c).

Case 1(d). $\alpha(G^*) = 3$, u_{k-1}^* is type (N), u_k^* is type (K) or (N), and u_{k+1}^* is type (N) for some $k \in [2, D-1]$: As illustrated in Figure 20, consider $x \neq u_{k-1}$ in u_{k-1}^* , $y \neq u_k$ in u_k^* , and $z \neq u_{k+1}$ in u_{k+1}^* . By Corollary 2.4, we may assume that $W = \{x, y, z\}$. Now $x \not\sim u_{k-1}$ and $z \not\sim u_{k+1}$. Thus $\text{dist}(x, u_{k-1}) = \text{dist}(x, u_{k+1}) = 2$, $\text{dist}(y, u_{k-1}) = \text{dist}(y, u_{k+1}) = 1$, and $\text{dist}(z, u_{k-1}) = \text{dist}(z, u_{k+1}) = 2$. Thus $\{x, y, z\}$ does not resolve u_{k-1}, u_{k+1} , which is a contradiction.

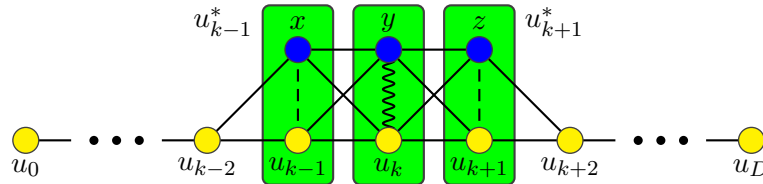

Figure 20: $\{x, y, z\}$ does not resolve u_{k-1}, u_{k+1} in Case 1(d).

Case 2. $G^* \cong P_{D+1,k}$ for some $k \in [3, D-1]$: Thus G^* is path $(u_0^*, u_1^*, \dots, u_D^*)$ plus one vertex w^* adjacent to u_{k-1}^* . As illustrated in Figure 21, suppose that every vertex of G^* is of type (1), except for u_{k-2}^*, u_k^* and w^* which are type (1N), and u_{k-1}^* which is of any type. In this case $n - D - 1 = \alpha(G^*) + 1$. Consequently, it suffices to prove that $\alpha(G^*) + 1$ vertices do not resolve G . Suppose there is a resolving set W in G of cardinality $\alpha(G^*) + 1$. By Corollary 2.4, we can assume that W contains the $\alpha(G^*)$ twins of u_{k-2}, u_{k-1}, u_k and w (if they exist), and another vertex of G . Let x_{k-2}, x_{k-1}, x_k and y respectively be twin vertices of u_{k-2}, u_{k-1}, u_k and w (if they exist). Then $x_{k-2} \not\sim u_{k-2}$, $x_k \not\sim u_k$, and $y \not\sim w$. Thus the distance from x_{k-2} (respectively x_{k-1}, x_k, y) to any vertex of u_{k-2}, u_k, w is 2 (respectively 1, 2, 2). Hence any set of twins of vertices in $\{u_{k-2}, u_{k-1}, u_k, w\}$ (if they

exist) does not resolve $\{u_{k-2}, u_k, w\}$. Moreover, if $i \in [0, k-1]$ then u_i does not resolve u_k, w ; if $i \in [k-1, D]$ then u_i does not resolve u_{k-2}, w ; and w does not resolve u_{k-2}, u_k . Therefore, $\alpha(G^*) + 1$ vertices do not resolve G .

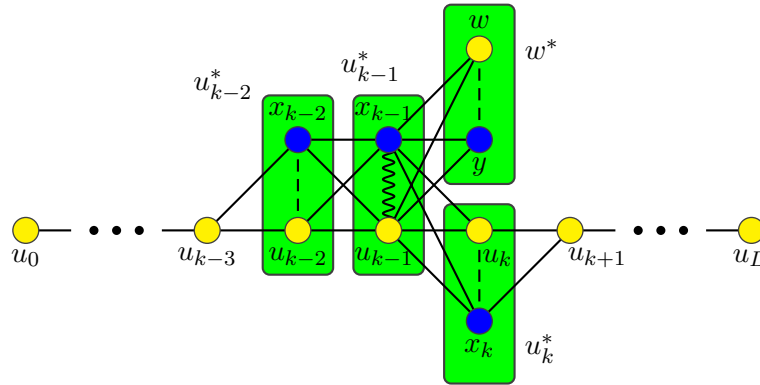

Figure 21: $\{x_{k-2}, x_{k-1}, x_k, y\}$ does not resolve $\{u_{k-2}, u_k, w\}$ in Case 2.

Case 3. $G^* \cong P'_{D+1,k}$ for some $k \in [2, D-1]$: Thus G^* is path $(u_0^*, u_1^*, \dots, u_D^*)$ plus one vertex w^* adjacent to u_{k-1}^* and u_k^* . As illustrated in Figure 22, suppose that every vertex of G^* is type (1) except for u_{k-1}^* , u_k^* , and w^* which are of type (1K). In this case, $n - D - 1 = \alpha(G^*) + 1$. Consequently, it suffices to prove that $\alpha(G^*) + 1$ vertices do not resolve G . Suppose there is a resolving set W in G of cardinality $\alpha(G^*) + 1$. By Corollary 2.4, we may assume that W contains exactly the $\alpha(G^*)$ twin vertices of u_{k-1}, u_k and w (if they exist), and another vertex of G . Let x_{k-1}, x_k , and y respectively be twins of u_{k-1}, u_k and w (if they exist). Hence $x_{k-1} \sim u_{k-1}$, $x_k \sim u_k$ and $y \sim w$. Consequently, u_{k-1}, u_k and w are at distance 1 from x_{k-1}, x_k and y . Thus any set of twins of vertices in $\{u_{k-1}, u_k, w\}$ (if they exist) does not resolve $\{u_{k-1}, u_k, w\}$. Moreover, if $i \in [0, k-1]$ then u_i does not resolve u_k, w ; if $i \in [k, D]$ then u_i does not resolve u_{k-1}, w ; and w does not resolve u_{k-1}, u_k . Thus $\alpha(G^*) + 1$ vertices do not resolve G . \square

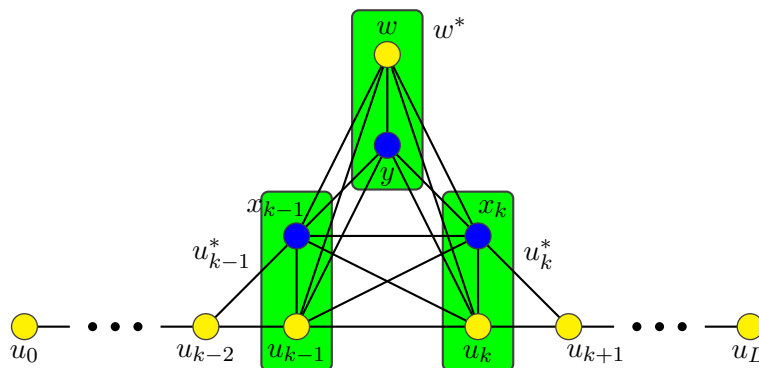

Figure 22: $\{x_{k-1}, x_k, y\}$ does not resolve $\{u_{k-1}, u_k, w\}$ in Case 3.

3 Graphs with Maximum Order

In this section we determine the maximum order of a graph in $\mathcal{G}_{\beta,D}$.

Theorem 3.1. *For all integers $D \geq 2$ and $\beta \geq 1$, the maximum order of a connected graph with diameter D and metric dimension β is*

$$\left(\left\lfloor \frac{2D}{3} \right\rfloor + 1 \right)^\beta + \beta \sum_{i=1}^{\lceil D/3 \rceil} (2i-1)^{\beta-1} . \quad (2)$$

First we prove the upper bound in Theorem 3.1.

Lemma 3.2. *For every graph $G \in \mathcal{G}_{\beta,D}$,*

$$|V(G)| \leq \left(\left\lfloor \frac{2D}{3} \right\rfloor + 1 \right)^\beta + \beta \sum_{i=1}^{\lceil D/3 \rceil} (2i-1)^{\beta-1} .$$

Proof. Let S be a metric basis of G . Let $k \in [0, D]$ be specified later. For each vertex $v \in S$ and integer $i \in [0, k]$, let $N_i(v) := \{x \in V(G) : \text{dist}(v, x) = i\}$.

Consider two vertices $x, y \in N_i(v)$. There is a path from x to v of length i , and there is a path from y to v of length i . Thus $\text{dist}(x, y) \leq 2i$. Hence for each vertex $u \in S$, the difference between $\text{dist}(u, x)$ and $\text{dist}(u, y)$ is at most $2i$. Thus the distance vector of x with respect to S has an i in the coordinate corresponding to v , and in each other coordinate, there are at most $2i + 1$ possible values. Therefore $|N_i(v)| \leq (2i + 1)^{\beta-1}$.

Consider a vertex $x \in V(G)$ that is not in $N_i(v)$ for all $v \in S$ and $i \in [0, k]$. Then $\text{dist}(x, v) \geq k + 1$ for all $v \in S$. Thus the distance vector of x with respect to S consists of β numbers in $[k + 1, D]$. Thus there are at most $(D - k)^\beta$ such vertices. Hence

$$\begin{aligned} |V(G)| &\leq (D - k)^\beta + \sum_{v \in S} \sum_{i=0}^k |N_i(v)| \\ &\leq (D - k)^\beta + \beta \sum_{i=0}^k (2i + 1)^{\beta-1} . \end{aligned}$$

Note that with $k = 0$ we obtain the bound $|V(G)| \leq D^\beta + \beta$, independently due to Khuller et al. [21] and Chartrand et al. [5]. Instead we define $k := \lceil D/3 \rceil - 1$. Then $k \in [0, D]$ and

$$\begin{aligned} |V(G)| &\leq \left(D - \left\lfloor \frac{D}{3} \right\rfloor + 1 \right)^\beta + \beta \sum_{i=0}^{\lceil D/3 \rceil - 1} (2i + 1)^{\beta-1} \\ &= \left(\left\lfloor \frac{2D}{3} \right\rfloor + 1 \right)^\beta + \beta \sum_{i=1}^{\lceil D/3 \rceil} (2i - 1)^{\beta-1} . \end{aligned}$$

□

To prove the lower bound in Theorem 3.1 we construct a graph $G \in \mathcal{G}_{\beta,D}$ with as many vertices as in Equation (2). The following definitions apply for the remainder of this section. Let $A := \lceil D/3 \rceil$ and $B := \lceil D/3 \rceil + \lfloor D/3 \rfloor$. Consider the following subsets of \mathbb{Z}^β . Let

$$Q := \{(x_1, \dots, x_\beta) : A \leq x_i \leq D, i \in [1, \beta]\} .$$

For each $i \in [1, \beta]$ and $r \in [0, A - 1]$, let

$$P_{i,r} := \{(x_1, \dots, x_{i-1}, r, x_{i+1}, \dots, x_\beta) : x_j \in [B - r, B + r], j \neq i\} .$$

Let $P_i := \bigcup\{P_{i,r} : r \in [0, A - 1]\}$ and $P := \bigcup\{P_i : i \in [1, \beta]\}$. Let G be the graph with vertex set $V(G) := Q \cup P$, where two vertices (x_1, \dots, x_β) and (y_1, \dots, y_β) in $V(G)$ are adjacent if and only if $|y_i - x_i| \leq 1$ for each $i \in [1, \beta]$. Figures 23 and 24 illustrate G for $\beta = 2$ and $\beta = 3$ respectively.

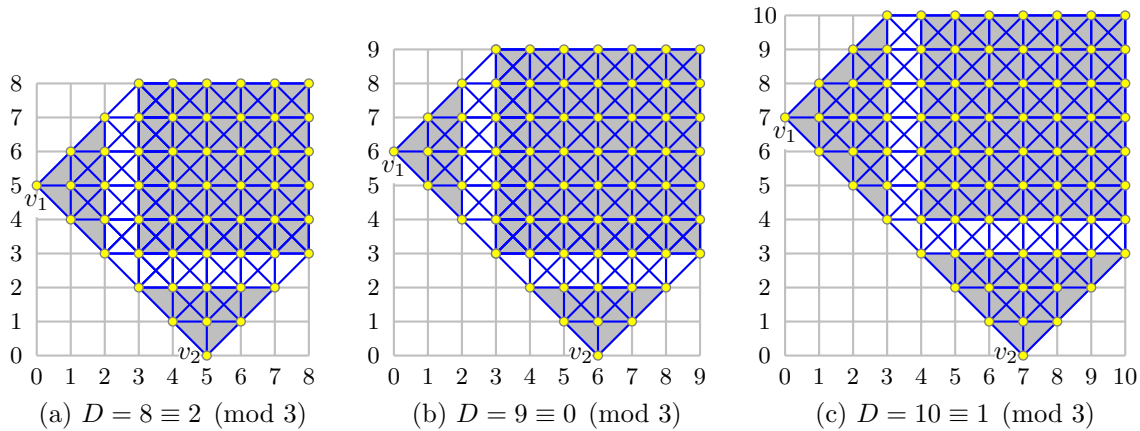

Figure 23: The graph G with $\beta = 2$. The shaded regions are Q , P_1 , and P_2 .

Lemma 3.3. *For all positive integers D and β ,*

$$|V(G)| = \left(\left\lfloor \frac{2D}{3} \right\rfloor + 1 \right)^\beta + \beta \sum_{i=1}^{\lfloor D/3 \rfloor} (2i - 1)^{\beta-1} .$$

Proof. Observe that each coordinate of each vertex in Q is at least A , and each vertex in P has some coordinate less than A . Thus $Q \cap P = \emptyset$. Each vertex in P_j ($j \neq i$) has an i -coordinate at least $B - r \geq B - (A - 1) = \lfloor D/3 \rfloor + 1$, and each vertex in P_i has an i -coordinate of $r \leq A - 1 < \lfloor D/3 \rfloor + 1$. Thus $P_i \cap P_j = \emptyset$ whenever $i \neq j$. Each vertex in

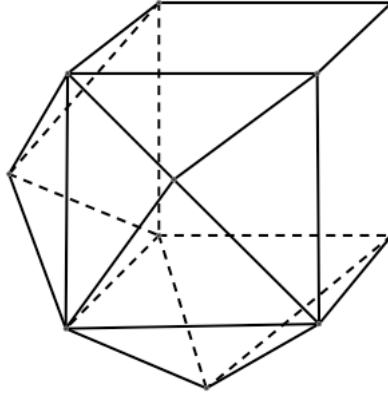

Figure 24: The convex hull of $V(G)$ with $\beta = 3$.

$P_{i,r}$ has an i -coordinate of r . Thus $P_{i,r} \cap P_{i,s} = \emptyset$ whenever $r \neq s$. Thus

$$\begin{aligned}
 |V(G)| &= |Q| + \sum_{i=1}^{\beta} \sum_{r=0}^{A-1} |P_{i,r}| \\
 &= \left(D - \left(\left\lfloor \frac{D}{3} \right\rfloor - 1 \right) \right)^{\beta} + \beta \sum_{r=0}^{A-1} (2r+1)^{\beta-1} \\
 &= \left(\left\lfloor \frac{2D}{3} \right\rfloor + 1 \right)^{\beta} + \beta \sum_{r=1}^A (2r-1)^{\beta-1} .
 \end{aligned}$$

□

We now determine the diameter of G . For distinct vertices $x = (x_1, \dots, x_{\beta})$ and $y = (y_1, \dots, y_{\beta})$ of G , let $z(x, y) := (z_1, \dots, z_{\beta})$ where

$$z_i = \begin{cases} x_i & \text{if } x_i = y_i, \\ x_i + 1 & \text{if } x_i < y_i, \\ x_i - 1 & \text{if } x_i > y_i . \end{cases}$$

Lemma 3.4. $z(x, y) \in V(G)$ for all distinct vertices $x, y \in V(G)$.

Proof. The following observations are an immediate consequence of the definition of $z(x, y)$, where $h, k \in \mathbb{Z}$ and $j \in [1, \beta]$:

- (i) if $x_j, y_j \in [h, k]$ then $z_j \in [h, k]$;
- (ii) if $x_j \in [h, k]$ then $z_j \in [h-1, k+1]$; and
- (iii) if $x_j \in [h, k]$ and $y_j \in [h', k']$ for some $h' > h$ and $k' < k$, then $z_j \in [h+1, k-1]$.

We distinguish the following cases:

- (1) $x, y \in Q$: Then $x_j, y_j \in [A, D]$ for all j . Thus $z_j \in [A, D]$ by (i). Hence $z \in Q$.
- (2) $x \in P$ and $y \in Q$: Without loss of generality, $x \in P_{1,r}$; that is, $x = (r, x_2, \dots, x_\beta)$, where $r \in [0, A - 1]$ and $x_j \in [B - r, B + r]$. Since $y \in Q$, we have $y_1 \geq A > r$. Thus $z = (r + 1, z_2, \dots, z_\beta)$.
 - (2.1) $z_1 = r + 1 < A$: By (ii), $z_j \in [B - r - 1, B + r + 1]$ for every $j \neq 1$. Thus $z \in P_{1,r+1}$.
 - (2.2) $z_1 = r + 1 = A$: Then $z_1 \in [A, D]$. On the other hand, if $j \neq 2$ then $y_j \geq A$, and since $x \in P_{1,r}$ and $r = A - 1$, we have $x_j \geq B - r = \lfloor D/3 \rfloor + 1 \geq \lceil D/3 \rceil = A$. Thus $z_j \geq A$. Hence $z \in Q$.
- (3) $x \in Q$ and $y \in P$: Without loss of generality, $y \in P_{1,r}$. That is, $y = (r, y_2, \dots, y_\beta)$, where $r \in [0, A - 1]$, $y_j \in [B - r, B + r]$, and $x = (x_1, \dots, x_\beta)$, where $x_j \geq A$ for all j . That is, $x_1 > r = y_1$, and therefore $z = (x_1 - 1, z_2, \dots, z_\beta)$.
 - (3.1) $z_1 = x_1 - 1 \geq A$: Since $x_j, y_j \geq A$, by (i), $z_j \geq A$ for every $j \neq 1$. That is, $z \in Q$.
 - (3.2) $z_1 = x_1 - 1 = A - 1$: Since $r \leq A - 1$, we have $y_j \in [B - r, B + r] \subseteq [B - (A - 1), B + A - 1]$ for all $j \notin \{1, 2\}$. Now $B - A = \lfloor D/3 \rfloor \leq \lceil D/3 \rceil = A$ and $D \leq \lfloor D/3 \rfloor + 2\lceil D/3 \rceil = A + B$. Thus $x_j \in [B - A, B + A]$. By (iii), $z_j \in [B - (A - 1), B + A - 1]$. That is, $z \in P_{1,A-1}$.
- (4) $x, y \in P_h$: Without loss of generality, $x, y \in P_1$. Thus $x = (r, x_2, \dots, x_\beta)$ for some $r \in [0, A - 1]$ with $x_j \in [B - r, B + r]$ for all $j \neq 1$, and $y = (s, y_2, \dots, y_\beta)$ for some $s \in [0, A - 1]$ with $y_j \in [B - s, B + s]$ for all $j \neq 1$.
 - (4.1) $r = s$: Then $z = (r, z_2, \dots, z_\beta)$. By (i), $z_j \in [B - r, B + r]$ for all $j \neq 1$. Thus $z \in P_{1,r}$.
 - (4.2) $r < s$: Then $z = (r + 1, z_2, \dots, z_\beta)$. By (ii), $z_j \in [B - (r + 1), B + r + 1]$ for all $j \neq 1$. Thus $z \in P_{1,r+1}$.
 - (4.3) $r > s$: Then $z = (r - 1, z_2, \dots, z_\beta)$. By (iii), $z_j \in [B - (r - 1), B + r - 1]$. Thus $z \in P_{1,r-1}$.
- (5) $x \in P_h, y \in P_k$ and $h \neq k$: Without loss of generality, $x \in P_1$ and $y \in P_2$. Thus $x = (r, x_2, \dots, x_\beta)$ for some $r \in [0, A - 1]$ with $x_j \in [B - r, B + r]$ for all $j \neq 1$, and $y = (y_1, s, y_3, \dots, y_\beta)$ for some $s \in [0, A - 1]$ with $y_j \in [B - s, B + s]$ for all $j \neq 2$. Hence $r < A \leq y_1$ and $s < A \leq x_2$, implying $z = (r + 1, x_2 - 1, z_3, \dots, z_\beta)$.
 - (5.1) $z_1 = r + 1 < A$: Now $x_j \in [B - r, B + r]$ for $j \neq 1$. Thus $z_j \in [B - r - 1, B + r + 1]$ by (ii). Thus $z \in P_{1,r+1}$.
 - (5.2) $z_1 = r + 1 = A$: Consider the following subcases:

- (5.2.1) $z_2 = x_2 - 1 \geq A$: By hypotheses, $z_1, z_2 \geq A$. For $j \notin \{1, 2\}$, since $x_j, y_j \geq A$, (i) implies that $z_j \geq A$. Thus $z \in Q$.
- (5.2.2) $z_2 = x_2 - 1 = A - 1$: In this case $x = (A - 1, A, x_3, \dots, x_\beta)$, $z = (A, A - 1, z_3, \dots, z_\beta)$, and $s \leq A - 1 = r$. Since $x \in P_{1, A-1}$, we have $z_1 = x_2 = A \in [B - (A - 1), B + A - 1]$. For $j \notin \{1, 2\}$, since $x_j \in [B - (A - 1), B + A - 1]$ and $y_j \in [B - s, B + s]$, where $s \leq r = A - 1$, (i) implies that $z_j \in [B - (A - 1), B + A - 1]$. That is, $z \in P_{2, A-1}$.

□

Lemma 3.5. For all vertices $x = (x_1, \dots, x_\beta)$ and $y = (y_1, \dots, y_\beta)$ of G ,

$$\text{dist}(x, y) = \max\{|y_i - x_i| : i \in [1, \beta]\} \leq D.$$

Proof. For each $i \in [1, \beta]$, $\text{dist}(x, y) \geq |x_i - y_i|$ since on every xy -path P , the i -coordinates of each pair of adjacent vertices in P differ by at most 1. This proves the lower bound $\text{dist}(x, y) \geq \max_i |y_i - x_i|$.

Now we prove the upper bound $\text{dist}(x, y) \leq \max_i |y_i - x_i|$ by induction. If $\max_i |y_i - x_i| = 1$ then x and y are adjacent, and thus $\text{dist}(x, y) = 1$. Otherwise, let $z := z(x, y)$. By the definition of $z(x, y)$, for all $i \in [1, \beta]$ we have $|y_i - z_i| = |y_i - x_i| - 1$ unless $x_i = y_i$. Thus $\max_i |y_i - z_i| = \max_i |y_i - x_i| - 1$. By induction, $\text{dist}(z, y) \leq \max_i |y_i - z_i| = \max_i |y_i - x_i| - 1$. By Lemma 3.4, z is a vertex of G , and by construction, x and z are adjacent. Thus $\text{dist}(x, y) \leq \text{dist}(z, y) + 1 = \max_i |y_i - x_i|$, as desired. □

Lemma 3.5 implies that G has diameter D . Let $S := \{v_1, \dots, v_\beta\}$, where

$$v_i = (\underbrace{B, \dots, B}_{i-1}, 0, B, \dots, B) .$$

Observe that each $v_i \in P_i$. We now prove that S is a metric basis of G .

Lemma 3.6. $\text{dist}(x, v_i) = x_i$ for every vertex $x = (x_1, \dots, x_\beta)$ of G and for each $v_i \in S$.

Proof. Let $v_{i,j}$ be the j -th coordinate of v_i ; that is, $v_{i,i} = 0$ and $v_{i,j} = B$ for $i \neq j$. Then $\text{dist}(x, v_i) = \max\{|v_{i,j} - x_j| : 1 \leq j \leq \beta\} = \max\{x_i, \max\{|B - x_j| : 1 \leq j \leq \beta, j \neq i\}\}$. We claim that $|B - x_j| \leq x_i$ for each $j \neq i$, implying $\text{dist}(x, v_i) = x_i$, as desired.

First suppose that $x \in Q$. Then $A \leq x_j \leq D$. Thus $|B - x_j| \leq \max\{B - A, D - B\} = \max\{\lfloor D/3 \rfloor, D - B\} \leq \max\{\lfloor D/3 \rfloor, \lceil D/3 \rceil\} = \lceil D/3 \rceil \leq x_i$.

Now suppose that $x \in P_{k,r}$ for some $k \neq i$ and for some r . Then $x_i \geq B - r \geq B - (\lceil D/3 \rceil - 1) = \lfloor D/3 \rfloor + 1 \geq \lceil D/3 \rceil$. Now $|B - x_j| \leq r \leq \lceil D/3 \rceil - 1$. Thus $|B - x_j| \leq x_i$.

Finally suppose that $x \in P_{i,r}$ for some r . Then $|B - x_j| \leq r = x_i$. □

Lemma 3.6 implies that the metric coordinates of a vertex $x \in V(G)$ with respect to S are its coordinates as elements of \mathbb{Z}^β . Therefore S resolves G . Thus G has metric dimension at most $|S| = \beta$.

If the metric dimension of G was less than β , then by Lemma 3.2,

$$\left(\left\lfloor \frac{2D}{3} \right\rfloor + 1\right)^\beta + \beta \sum_{i=1}^{\lceil D/3 \rceil} (2i-1)^{\beta-1} = |V(G)| \leq \left(\left\lfloor \frac{2D}{3} \right\rfloor + 1\right)^{\beta-1} + (\beta-1) \sum_{i=1}^{\lceil D/3 \rceil} (2i-1)^{\beta-2},$$

which is a contradiction. Thus G has metric dimension β , and $G \in \mathcal{G}_{\beta,D}$. This completes the proof of Theorem 3.1.

References

- [1] ZUZANA BEERLIOVA, FELIX EBERHARD, THOMAS ERLEBACH, ALEXANDER HALL, MICHAEL HOFFMANN, MATÚŠ MIHAL'ÁK, AND L. SHANKAR RAM. Network discovery and verification. *IEEE J. on Selected Areas in Communications*, 24(12):2168–2181, 2006.
- [2] ROBERT C. BRIGHAM, GARY CHARTRAND, RONALD D. DUTTON, AND PING ZHANG. Resolving domination in graphs. *Math. Bohem.*, 128(1):25–36, 2003.
- [3] JOSÉ CÁCERES, CARMEN HERNANDO, MERCÈ MORA, IGNACIO M. PELAYO, MARÍA L. PUERTAS, CARLOS SEARA, AND DAVID R. WOOD. On the metric dimension of cartesian products of graphs. *SIAM J. Discrete Math.*, 21(2):423–441, 2007. <http://dx.doi.org/10.1137/050641867>.
- [4] GLENN G. CHAPPELL, JOHN GIMBEL, AND CHRIS HARTMAN. Bounds on the metric and partition dimensions of a graph. *Ars Combin.*, 88:349–366, 2008.
- [5] GARY CHARTRAND, LINDA EROH, MARK A. JOHNSON, AND ORTRUD R. OELLERMANN. Resolvability in graphs and the metric dimension of a graph. *Discrete Appl. Math.*, 105(1–3):99–113, 2000. [http://dx.doi.org/10.1016/S0166-218X\(00\)00198-0](http://dx.doi.org/10.1016/S0166-218X(00)00198-0)
- [6] GARY CHARTRAND, CHRISTOPHER POISSON, AND PING ZHANG. Resolvability and the upper dimension of graphs. *Comput. Math. Appl.*, 39(12):19–28, 2000.
- [7] GARY CHARTRAND AND PING ZHANG. The theory and applications of resolvability in graphs. A survey. In *Proc. 34th Southeastern International Conf. on Combinatorics, Graph Theory and Computing*, vol. 160 of *Congr. Numer.*, pp. 47–68. 2003.
- [8] VAŠEK CHVÁTAL. Mastermind. *Combinatorica*, 3(3-4):325–329, 1983.
- [9] JAMES CURRIE AND ORTRUD R. OELLERMANN. The metric dimension and metric independence of a graph. *J. Combin. Math. Combin. Comput.*, 39:157–167, 2001.
- [10] REINHARD DIESTEL. *Graph theory*, vol. 173 of *Graduate Texts in Mathematics*. Springer, 2nd edn., 2000. <http://diestel-graph-theory.com/index.html>.
- [11] PAUL ERDŐS AND ALFRÉD RÉNYI. On two problems of information theory. *Magyar Tud. Akad. Mat. Kutató Int. Közl.*, 8:229–243, 1963.
- [12] WAYNE GODDARD. Static mastermind. *J. Combin. Math. Combin. Comput.*, 47:225–236, 2003.

- [13] WAYNE GODDARD. Mastermind revisited. *J. Combin. Math. Combin. Comput.*, 51:215–220, 2004.
- [14] DON L. GREENWELL. Mastermind. *J. Recr. Math.*, 30:191–192, 1999-2000.
- [15] RICHARD K. GUY AND RICHARD J. NOWAKOWSKI. Coin-weighing problems. *Amer. Math. Monthly*, 102(2):164, 1995. <http://www.jstor.org/stable/2975353>.
- [16] FRANK HARARY AND ROBERT A. MELTER. On the metric dimension of a graph. *Ars Combinatoria*, 2:191–195, 1976.
- [17] CARMEN HERNANDO, MERCÉ MORA, PETER J. SLATER, AND DAVID R. WOOD. Fault-tolerant metric dimension of graphs. In *Convexity in discrete structures*, vol. 5 of *Ramanujan Math. Soc. Lect. Notes Ser.*, pp. 81–85. Ramanujan Math. Soc., 2008.
- [18] H. ISWADI, E. T. BASKORO, R. SIMANJUNTAK, AND A. N. M. SALMAN. The metric dimension of graph with pendant edges. *J. Combin. Math. Combin. Comput.*, 65:139–145, 2008.
- [19] IMRAN JAVAID, M. TARIQ RAHIM, AND KASHIF ALI. Families of regular graphs with constant metric dimension. *Util. Math.*, 75:21–33, 2008.
- [20] GRIGORI KABATIANSKI, V. S. LEBEDEV, AND J. THORPE. The Mastermind game and the rigidity of Hamming spaces. In *Proc. IEEE International Symposium on Information Theory (ISIT '00)*, p. 375. IEEE, 2000.
- [21] SAMIR KHULLER, BALAJI RAGHAVACHARI, AND AZRIEL ROSENFELD. Landmarks in graphs. *Discrete Appl. Math.*, 70(3):217–229, 1996. [http://dx.doi.org/10.1016/0166-218X\(95\)00106-2](http://dx.doi.org/10.1016/0166-218X(95)00106-2).
- [22] BERNT LINDSTRÖM. On a combinatorial detection problem. I. *Magyar Tud. Akad. Mat. Kutató Int. Közl.*, 9:195–207, 1964.
- [23] PAUL MANUEL, BHARATI RAJAN, INDRA RAJASINGH, AND M. CHRIS MONICA. Landmarks in torus networks. *J. Discrete Math. Sci. Cryptogr.*, 9(2):263–271, 2006.
- [24] PAUL MANUEL, BHARATI RAJAN, INDRA RAJASINGH, AND CHRIS MONICA M. On minimum metric dimension of honeycomb networks. *J. Discrete Algorithms*, 6(1):20–27, 2008. <http://dx.doi.org/10.1016/j.jda.2006.09.002>.
- [25] ORTRUD R. OELLERMANN AND JOEL PETERS-FRANSEN. The strong metric dimension of graphs and digraphs. *Discrete Appl. Math.*, 155(3):356–364, 2007. <http://dx.doi.org/10.1016/j.dam.2006.06.009>.
- [26] JOEL PETERS-FRANSEN AND ORTRUD R. OELLERMANN. The metric dimension of the cartesian product of graphs. *Utilitas Math.*, 69:33–41, 2006.
- [27] CHRISTOPHER POISSON AND PING ZHANG. The metric dimension of unicyclic graphs. *J. Combin. Math. Combin. Comput.*, 40:17–32, 2002.
- [28] BHARATI RAJAN, INDRA RAJASINGH, M. CHRIS MONICA, AND PAUL MANUEL. Metric dimension of enhanced hypercube networks. *J. Combin. Math. Combin. Comput.*, 67:5–15, 2008.
- [29] VARAPORN SAENPHOLPHAT AND PING ZHANG. Connected resolvability of graphs. *Czechoslovak Math. J.*, 53(128)(4):827–840, 2003.

- [30] VARAPORN SAENPHOLPHAT AND PING ZHANG. Conditional resolvability in graphs: a survey. *Int. J. Math. Math. Sci.*, (37-40):1997–2017, 2004.
- [31] VARAPORN SAENPHOLPHAT AND PING ZHANG. Detour resolvability of graphs. In *Proc. of 35th Southeastern International Conf. on Combinatorics, Graph Theory and Computing*, vol. 169, pp. 3–21. 2004.
- [32] VARAPORN SAENPHOLPHAT AND PING ZHANG. On connected resolving decompositions in graphs. *Czechoslovak Math. J.*, 54(129)(3):681–696, 2004.
- [33] S. W. SAPUTRO, EDY TRI BASKORO, A. N. M. SALMAN, AND D. SUPRIJANTO. The metric dimensions of a complete n -partite graph and its Cartesian product with a path. *J. Combin. Math. Combin. Comput.*, 71:283–293, 2009.
- [34] ANDRÁS SEBŐ AND ERIC TANNIER. On metric generators of graphs. *Math. Oper. Res.*, 29(2):383–393, 2004.
- [35] B. SHANMUKHA, B. SOORYANARAYANA, AND K. S. HARINATH. Metric dimension of wheels. *Far East J. Appl. Math.*, 8(3):217–229, 2002.
- [36] PETER J. SLATER. Leaves of trees. In *Proc. 6th Southeastern Conf. on Combinatorics, Graph Theory, and Computing*, vol. 14 of *Congr. Numer.*, pp. 549–559. Utilitas Math., 1975.
- [37] PETER J. SLATER. Dominating and reference sets in a graph. *J. Math. Phys. Sci.*, 22(4):445–455, 1988.
- [38] STAFFAN SÖDERBERG AND HAROLD S. SHAPIRO. A combinatorial detection problem. *Amer. Math. Monthly*, 70:1066, 1963. <http://www.jstor.org/stable/2312835>.
- [39] B. SOORYANARAYANA. On the metric dimension of a graph. *Indian J. Pure Appl. Math.*, 29(4):413–415, 1998.
- [40] B. SOORYANARAYANA AND B. SHANMUKHA. A note on metric dimension. *Far East J. Appl. Math.*, 5(3):331–339, 2001.
- [41] IOAN TOMESCU. Discrepancies between metric dimension and partition dimension of a connected graph. *Discrete Math.*, 308(22):5026–5031, 2008. <http://dx.doi.org/10.1016/j.disc.2007.08.089>.
- [42] S. V. YUSHMANOV. Estimates for the metric dimension of a graph in terms of the diameters and the number of vertices. *Vestnik Moskov. Univ. Ser. I Mat. Mekh.*, 103:68–70, 1987.