

On essentially 4-edge-connected cubic bricks

Nishad Kothari*

University of Campinas, Brazil

nishadkothari@gmail.com

Marcelo H. de Carvalho[†]

UFMS Campo Grande, Brazil

mhc@facom.ufms.br

Cláudio L. Lucchesi[‡]

University of Campinas, Brazil

lucchesi@ic.unicamp.br

Charles H. C. Little

Massey University, New Zealand

c.little@massey.ac.nz

Submitted: Mar 18, 2019; Accepted: Dec 20, 2019; Published: Jan 24, 2020

© The authors. Released under the CC BY-ND license (International 4.0).

Dedicated to Professor U. S. R. Murty on the year of his 80th birthday

Abstract

Lovász (1987) proved that every matching covered graph G may be uniquely decomposed into a list of bricks (nonbipartite) and braces (bipartite); we let $b(G)$ denote the number of bricks. An edge e is removable if $G - e$ is also matching covered; furthermore, e is b -invariant if $b(G - e) = 1$, and e is quasi- b -invariant if $b(G - e) = 2$. (Each edge of the Petersen graph is quasi- b -invariant.)

A brick G is near-bipartite if it has a pair of edges $\{e, f\}$ so that $G - e - f$ is matching covered and bipartite; such a pair $\{e, f\}$ is a removable doubleton. (Each of K_4 and the triangular prism $\overline{C_6}$ has three removable doubletons.) Carvalho, Lucchesi and Murty (2002) proved a conjecture of Lovász which states that every brick, distinct from K_4 , $\overline{C_6}$ and the Petersen graph, has a b -invariant edge.

A cubic graph is essentially 4-edge-connected if it is 2-edge-connected and if its only 3-cuts are the trivial ones; it is well-known that each such graph is either a brick or a brace; we provide a graph-theoretical proof of this fact.

We prove that if G is any essentially 4-edge-connected cubic brick then its edge-set may be partitioned into three (possibly empty) sets: (i) edges that participate in a removable doubleton, (ii) b -invariant edges, and (iii) quasi- b -invariant edges; our Main Theorem states that if G has two adjacent quasi- b -invariant edges, say e_1 and e_2 , then either G is the Petersen graph or the (near-bipartite) Cubeplex graph, or otherwise, each edge of G (distinct from e_1 and e_2) is b -invariant. As a

*Supported by Austrian Science Foundation FWF (START Y463) and FAPESP Brazil (2018/04679-1).

[†]Supported by Fundect-MS and CNPq.

[‡]Supported by CNPq.

corollary, we deduce that each essentially 4-edge-connected cubic non-near-bipartite brick G , distinct from the Petersen graph, has at least $|V(G)|$ b -invariant edges.

Mathematics Subject Classifications: 05C70, 05C75, 05C40

1 Matching covered graphs

A graph is *matchable* if it has a perfect matching. Tutte [26] proved his celebrated 1-factor Theorem characterizing matchable graphs, and deduced as a corollary that in a 2-edge-connected cubic graph each edge lies in a perfect matching.

Let G be a matchable graph. A nonempty subset S of its vertices is a *barrier* if it satisfies the equation $\text{odd}(G - S) = |S|$, where $\text{odd}(G - S)$ denotes the number of odd components of $G - S$. For distinct vertices u and v of G , it is easily deduced from Tutte's Theorem that the graph $G - u - v$ is matchable if and only if no barrier of G contains both u and v . A barrier is *trivial* if it has a single vertex.

An edge e of G is *admissible* if there is some perfect matching of G that contains e ; otherwise it is *inadmissible*. Clearly, an edge e is admissible if and only if no barrier of G contains both ends of e .

A connected graph with two or more vertices is *matching covered* if each of its edges is admissible. The observation made above implies that a matchable graph G is matching covered if and only if every barrier of G is stable. The following fundamental theorem is due to Kotzig; see [18, p. 150].

Theorem 1. *The maximal barriers of a matching covered graph partition its vertex set.*

The aforementioned corollary of Tutte's Theorem may be rephrased as follows.

Theorem 2. *A cubic graph is matching covered if and only if it is 2-edge-connected.*

1.1 Tight cut decompositions

For a nonempty proper subset X of the vertices of a graph G , we denote by $\partial(X)$ the cut associated with X , that is, the set of all edges of G that have one end in X and the other end in $\bar{X} := V(G) - X$. We refer to X and \bar{X} as the *shores* of $\partial(X)$. A cut is *trivial* if either of its shores is a singleton. We say that $\partial(X)$ is a *k-cut* if $|\partial(X)| = k$.

For a cut $\partial(X)$, we denote the graph obtained by contracting the shore X to a single vertex x by $G/(X \rightarrow x)$. The graph $G/(\bar{X} \rightarrow \bar{x})$ is defined analogously. In case the label of the contraction vertex x or \bar{x} is irrelevant, we simply write G/X or G/\bar{X} , respectively. The two graphs G/X and G/\bar{X} are called the $\partial(X)$ -*contractions* of G . In Figure 1(a), the three edges crossing the bold line constitute a nontrivial cut, say $\partial(X)$, and the two $\partial(X)$ -contractions are K_4 and $K_{3,3}$.

A cut $\partial(X)$ of a matching covered graph G is a *separating cut* if each $\partial(X)$ -contraction of G is also matching covered. Clearly, each trivial cut is a separating cut. The triangular prism \bar{C}_6 has a (unique) nontrivial 3-cut $\partial(X)$ that is a separating cut. More generally, if G is cubic, and if $\partial(X)$ is any 3-cut, then each $\partial(X)$ -contraction of G is a cubic graph that is 2-edge-connected; whence, by Theorem 2, we have the following.

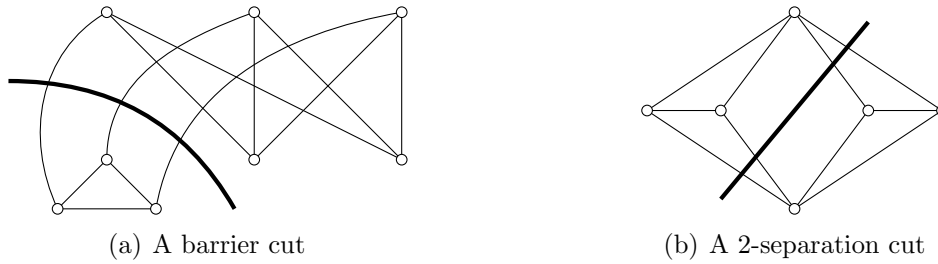

Figure 1: Nontrivial tight cuts

Proposition 3. *In a cubic matching covered graph, each 3-cut is a separating cut.* \square

However, a cubic matching covered graph may have a separating cut that is not a 3-cut. For instance, the Petersen graph has nontrivial separating cuts, each of which is a 5-cut; for any such cut $\partial(X)$, each of the $\partial(X)$ -contractions is isomorphic to the odd wheel W_5 .

A cut $\partial(X)$ is a *tight cut* if $|M \cap \partial(X)| = 1$ for every perfect matching M of G . It is easily verified that every tight cut is a separating cut. The converse is not true. For instance, as noted earlier, $\overline{C_6}$ has a nontrivial separating cut; however, $\overline{C_6}$ is free of nontrivial tight cuts.

For instance, if B is a barrier of G , and K is an odd component of $G - B$, then $\partial(V(K))$ is a tight cut of G . Such a tight cut is called a *barrier cut associated with the barrier B* , or simply a *barrier cut*. The graph in Figure 1(a) has a barrier cut depicted by the bold line, and each of its contractions (that is, K_4 and $K_{3,3}$) is free of nontrivial tight cuts.

By a *2-separation*, we mean a 2-vertex-cut. Now suppose that $\{u, v\}$ is a 2-separation of G that is not a barrier; that is, each component of $G - u - v$ is even. Let K be a subgraph that is formed by the union of some, but not all, components of $G - u - v$. Then each of the sets $V(K) \cup \{u\}$ and $V(K) \cup \{v\}$ is a shore of a nontrivial tight cut of G . Such a tight cut is called a *2-separation cut associated with the 2-separation $\{u, v\}$* , or simply a *2-separation cut*. The graph in Figure 1(b) has a 2-separation cut, and each of its contractions is K_4 with multiple edges.

Let G be a matching covered graph. If $\partial(X)$ is a nontrivial tight cut of G , then each $\partial(X)$ -contraction is a matching covered graph that has strictly fewer vertices than G . If either of the $\partial(X)$ -contractions has a nontrivial tight cut, then that graph can be further decomposed into even smaller matching covered graphs. We can repeat this procedure until we obtain a list of matching covered graphs, each of which is free of nontrivial tight cuts. This procedure is known as a *tight cut decomposition* of G .

Let G be a matching covered graph free of nontrivial tight cuts. If G is bipartite then it is a *brace*; otherwise it is a *brick*. Thus, a tight cut decomposition of G results in a list of bricks and braces.

In general, a matching covered graph may admit several tight cut decompositions. However, Lovász [17] proved the following remarkable result.

Theorem 4. *Any two tight cut decompositions of a matching covered graph yield the same list of bricks and braces (except possibly for multiplicities of edges).*

In particular, any two tight cut decompositions of a matching covered graph G yield the same number of bricks; this number is denoted by $b(G)$. We remark that G is bipartite if and only if $b(G) = 0$.

A graph G , with four or more vertices, is *bicritical* if $G - u - v$ is matchable for every pair of distinct vertices u and v . For instance, the graph shown in Figure 1(b) is bicritical, whereas the graph shown in Figure 1(a) is not. It follows from Tutte's Theorem that a matchable graph G is bicritical if and only if every barrier of G is trivial.

Since a brick is a nonbipartite matching covered graph which is free of nontrivial tight cuts, it follows from the above observations that every brick is 3-connected and bicritical. Edmonds, Lovász and Pulleyblank [9] established the converse.

Theorem 5. *A graph is a brick if and only if it is 3-connected and bicritical.*

In fact, the difficult direction of their theorem statement is equivalent to the following.

Theorem 6. *If a matching covered graph has a nontrivial tight cut, then it has a nontrivial tight cut that is either a barrier cut or a 2-separation cut.*

For cubic graphs, one may easily deduce the following strengthening. (See Lemma 21.)

Corollary 7. *If a cubic matching covered graph has a nontrivial tight cut, then it has a nontrivial tight cut that is a barrier cut.*

In general, a cubic matching covered graph need not be a brick or a brace. For instance, the graph shown in Figure 1(a) has a nontrivial tight cut, and this particular cut happens to be a 3-cut. In fact, this is not a coincidence.

Theorem 8. *In a cubic matching covered graph, each tight cut is a 3-cut.*

The above theorem may be proved easily using Edmond's characterization of the perfect matching polytope by considering the vector that assigns $\frac{1}{3}$ to each edge (see [13]). A graph-theoretical proof of the above theorem appears in Section 2; it is rather straightforward, and was already known to C. N. Campos and C. L. Lucchesi in 1999.

We say that a cubic graph is *essentially 4-edge-connected* if it is 2-edge-connected and if it is free of nontrivial 3-cuts. (It is easy to see that such a graph is necessarily 3-edge-connected unless it is isomorphic to C_4 with multiple edges, and that it is triangle-free unless it is isomorphic to K_4 .) The following is an immediate consequence of Theorem 8.

Corollary 9. *Every essentially 4-edge-connected cubic graph is either a brick or a brace.*

However, there exist cubic bricks that are not essentially 4-edge-connected. For instance, the 'staircases' form one such infinite family; they play an important role in [23, 12]. The smallest staircase is $\overline{C_6}$, and the next two members are shown in Figure 2(b). Another example is the Tricorn; see Figure 2(a).

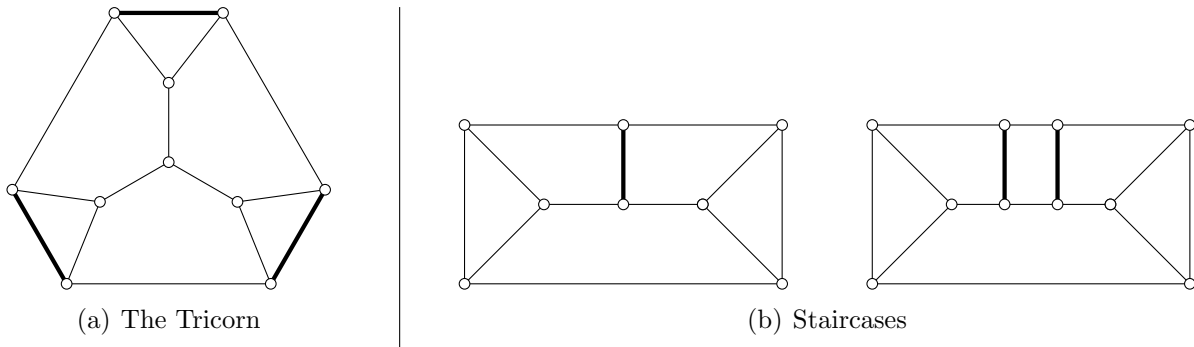

Figure 2: Some cubic bricks that are not essentially 4-edge-connected

On the other hand, every cubic brace is in fact essentially 4-edge-connected. This is due to Proposition 3, and the fact that, in a bipartite matching covered graph, every separating cut is also a tight cut; see [3, Corollary 2.22].

A matching covered graph G is *solid* if every separating cut of G is a tight cut; otherwise G is nonsolid. The class of solid graphs is thus a generalization of bipartite graphs, and it has played an important role in the theory of matching covered graphs; see [6, 7, 8, 20]. In particular, solid bricks are precisely those bricks that are free of nontrivial separating cuts. By Proposition 3, every cubic solid brick is essentially 4-edge-connected.

Two infinite families of essentially 4-edge-connected cubic graphs, worth mentioning here, are the ‘prisms’ and the ‘Möbius ladders’. See [12] for definitions. Each bipartite member of these families is a brace. The nonbipartite Möbius ladders are solid bricks, whereas the nonbipartite prisms are nonsolid bricks.

1.2 b -invariant edges

An edge e of a matching covered graph G is *removable* if $G - e$ is also matching covered. Furthermore, a removable edge e is *b -invariant* if $b(G - e) = b(G)$. Note that, if G is bipartite then any removable edge e is b -invariant since $b(G - e) = b(G) = 0$. Furthermore, it can be easily shown that if G is a brace of order six or more, then each edge is removable and thus b -invariant. However, the notions of removability and b -invariance are far more interesting, and nontrivial, in the case of bricks.

For a matching covered graph G , an edge e *depends on* another edge f if every perfect matching that contains e also contains f , and in this case the edge f is not removable. Two edges e and f are *mutually dependent* if e depends on f and f depends on e . Lovász [17] proved the following.

Proposition 10. *If $\{e, f\}$ is a pair of mutually dependent edges in a brick G then $G - e - f$ is a matchable bipartite graph.*

In particular, for a brick G , the complement of a pair of mutually dependent edges is a cut of G . Thus, if $\{e, f\}$ and $\{e, f'\}$ are distinct pairs of mutually dependent edges then the symmetric difference of their complements is a cut of G . That is, $\{f, f'\}$ is a cut of G . This is absurd since bricks are 3-edge-connected. This proves the following.

Corollary 11. *In a brick, any two distinct pairs of mutually dependent edges are disjoint.* \square

In general, for a brick G and a pair of mutually dependent edges $\{e, f\}$, the bipartite graph $G - e - f$ need not be matching covered. We say that $R := \{e, f\}$ is a *removable doubleton* if $G - R$ is matching covered (and bipartite). A brick G is *near-bipartite* if it has a removable doubleton; otherwise G is *non-near-bipartite*. For instance, the Petersen graph is non-near-bipartite. On the other hand, each of K_4 and the triangular prism $\overline{C_6}$ has three distinct removable doubletons; furthermore, each of them is devoid of removable edges. Lovász [17] proved that every brick distinct from K_4 and $\overline{C_6}$ has a removable edge.

If G is a brick and e is a removable edge then $b(G - e) \geq 1$, and in general, $b(G - e)$ can be arbitrarily large. A removable edge e of a brick G is *b-invariant* if and only if $b(G - e) = 1$. For instance, the Tricorn brick, shown in Figure 2(a), has precisely three removable edges (indicated by bold lines), each of which is *b-invariant*.

On the other hand, the Petersen graph is devoid of *b-invariant* edges despite the fact that each edge is removable. Confirming a conjecture of Lovász, the following result was proved by Carvalho, Lucchesi and Murty [4].

Theorem 12. *Every brick distinct from K_4 , $\overline{C_6}$ and the Petersen graph has a b-invariant edge.*

As an application of the above theorem, Carvalho, Lucchesi and Murty [5] gave an alternative proof for the characterization of the matching lattice, and proved other deep results concerning ‘ear decompositions’ of matching covered graphs. Since then, the existence of *b-invariant* edges in bricks, as well as the existence of special types of *b-invariant* edges (such as ‘thin’ and ‘strictly thin’ edges) in bricks and in braces, have found many applications in matching theory; see [21, 7, 8, 12].

In certain applications, it is helpful to have the presence of “many” *b-invariant* edges — for instance, one incident with each vertex. An immediate consequence of Theorem 3.3 and Corollary 6.12 in [8] is the following.

Theorem 13. *In a solid brick G , distinct from K_4 , each vertex is incident with at least one b-invariant edge; consequently, G has at least $\frac{|V(G)|}{2}$ b-invariant edges.*

In this paper, we establish a similar lower bound for another rich class of bricks.

Theorem 14. *Every essentially 4-edge-connected cubic non-near-bipartite brick G , distinct from the Petersen graph, has at least $|V(G)|$ b-invariant edges.*

We will prove a much stronger result that will immediately imply Theorem 14; on the way there, we will discover other noteworthy facts concerning the edges of an essentially 4-edge-connected cubic brick. These are discussed in the next section.

Figure 3 shows (two drawings of) an essentially 4-edge-connected cubic non-near-bipartite brick, of order 12, that has precisely 12 *b-invariant* edges (and 6 quasi-*b-invariant* edges that are indicated by bold lines); however, apart from this graph, we do not know of

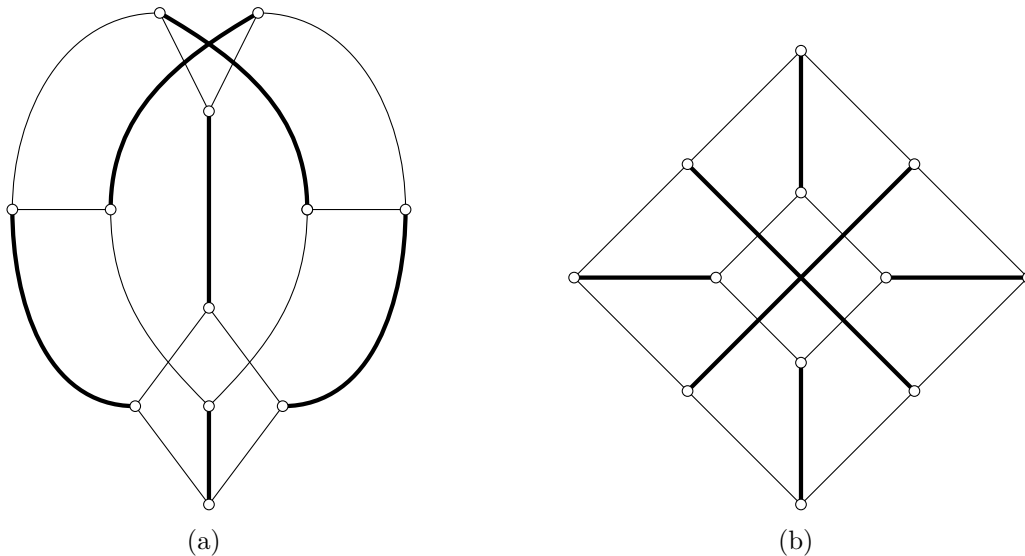

Figure 3: Two drawings of an essentially 4-edge-connected cubic non-near-bipartite brick G that has precisely $|V(G)|$ b -invariant edges

any other graph that meets the lower bound of Theorem 14. In fact, as per the results of our recent computations, each essentially 4-edge-connected cubic non-near-bipartite brick, of order at most 20, has no more than 6 quasi- b -invariant edges. (Is this a coincidence?)

It should be noted that the lower bound of Theorem 14 does not hold for cubic bricks, in general. For instance, each staircase G , shown in Figure 2(b), has exactly $\frac{|V(G)|-6}{2}$ b -invariant edges; these are near-bipartite but not essentially 4-edge-connected. The Tricorn, shown in Figure 2(a), is neither essentially 4-edge-connected nor near-bipartite, and it has exactly three b -invariant edges. (In Figure 2, the b -invariant edges are indicated by bold lines.)

On the other hand, we conjecture that a weaker lower bound holds for cubic bricks that are essentially 4-edge-connected and near-bipartite.

Conjecture 15. Every essentially 4-edge-connected cubic near-bipartite brick G , distinct from K_4 , has at least $\frac{|V(G)|}{2}$ b -invariant edges.

A proof of the above conjecture has already been announced by Lu, Feng and Wang [19]. Furthermore, they prove that prisms of order $4k + 2$, and Möbius ladder of order $4k$ (where $k \geq 2$) are the only graphs that attain the conjectured lower bound.

1.3 Edges of an essentially 4-edge-connected cubic brick

The triangular prism \overline{C}_6 has a nontrivial 3-cut C , and for each $e \in C$, the edge e is neither removable nor does it participate in a removable doubleton. We prove that this phenomenon cannot occur in essentially 4-edge-connected cubic bricks.

Theorem 16. *In an essentially 4-edge-connected cubic brick, each edge is either removable or otherwise participates in a removable doubleton.*

It should be noted that, in a brick, any edge can participate in at most one removable doubleton. See Corollary 11.

As mentioned earlier, for a removable edge e of a brick G , the quantity $b(G - e)$ may be arbitrarily large. This is also true for cubic bricks, in general. In Section 7, we describe how one may construct such cubic bricks. However, our next result shows that $b(G - e) \in \{1, 2\}$ if the brick under consideration is cubic as well as essentially 4-edge-connected.

A removable edge e of a brick is *quasi- b -invariant* if $b(G - e) = 2$. For instance, each edge of the Petersen graph is quasi- b -invariant.

Theorem 17. *In an essentially 4-edge-connected cubic brick, each removable edge is either b -invariant or otherwise quasi- b -invariant.*

The above theorem is reminiscent of the following result of Carvalho, Lucchesi and Murty [3].

Theorem 18. *In a solid brick, each removable edge is b -invariant.*

It follows from Theorems 16 and 17 that the edge set of an essentially 4-edge-connected cubic brick may be partitioned into three disjoint (possibly empty) sets: (i) edges that participate in a removable doubleton — these come in pairs, (ii) edges that are b -invariant, and (iii) edges that are quasi- b -invariant.

As mentioned earlier, it is often helpful to have the presence of “many” b -invariant edges. On a related note, a brick being near-bipartite is most likely “good” news. For instance, while there has been no significant progress in characterizing ‘Pfaffian’ bricks, Fischer and Little [10] were able to characterize Pfaffian near-bipartite bricks. (See Section 4 for definition and further discussion on this topic.) In this sense, the only “unpleasant” outcome for any particular edge e of an essentially 4-edge-connected cubic brick G is that it happens to be quasi- b -invariant. With this in mind, we started wondering whether we could prove an upper bound on the number of quasi- b -invariant edges in an essentially 4-edge-connected cubic brick. Such a result would yield a lower bound on the number of b -invariant edges — in the case that G is non-near-bipartite.

As noted earlier, in the Petersen graph, every edge is quasi- b -invariant. In particular, if v is any vertex, then all three edges incident with v are quasi- b -invariant. Our next result shows that, among the essentially 4-edge-connected cubic bricks, this phenomenon is unique to the Petersen graph. In fact, we prove the following stronger result that immediately implies Theorem 14 (see Section 6).

Theorem 19. [MAIN THEOREM] *Let G be an essentially 4-edge-connected cubic brick that has two adjacent quasi- b -invariant edges e_1 and e_2 . Then the following statements hold:*

- (i) *For $i \in \{1, 2\}$, both bricks of $G - e_i$ are isomorphic to K_4 (up to multiple edges).*
- (ii) *The graph G is nonsolid, nonplanar and non-Pfaffian.*

(iii) If G is near-bipartite then G is the Cubeplex.

(iv) If G has a quasi- b -invariant edge, distinct from e_1 and e_2 , then G is the Petersen graph.

Consequently, every edge of G , distinct from e_1 and e_2 , is b -invariant, unless G is either the Cubeplex or the Petersen graph.

The proof appears in Section 5. Figures 6(b) and 12 show the two special graphs that appear in Theorem 19. The Cubeplex first appeared in the work of Fischer and Little [10] where they showed that it is one of two minimally non-Pfaffian near-bipartite graphs; they referred to the two graphs as Γ_1 and Γ_2 . The names Cubeplex for Γ_1 , and Twinplex for Γ_2 , are due to Norine and Thomas [23]. (See Section 4 for further discussion.) Figure 4 shows the smallest essentially 4-edge-connected cubic brick that has a vertex v incident with precisely two quasi- b -invariant edges and one b -invariant edge. The choice of the specific drawings in Figures 3(a), 4, 6(b) and 12(a) is by no means coincidental; it is related to the proofs of Theorems 17 and 19.

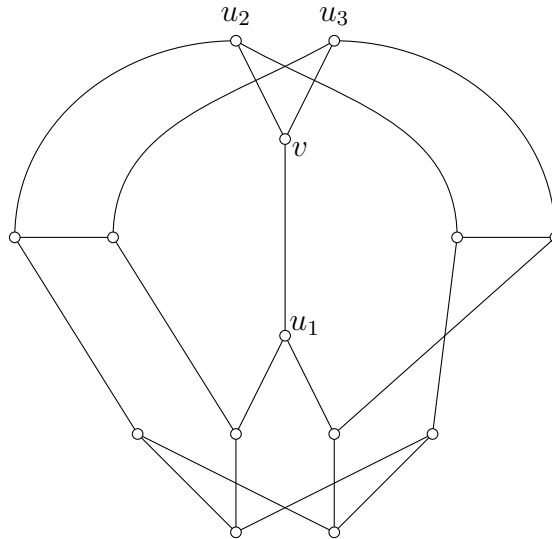

Figure 4: The edges vu_1 and vu_2 are quasi- b -invariant whereas vu_3 is b -invariant

Throughout this research, we made extensive use of computations — especially, in discovering the statement and proof of the Main Theorem (19). To this end, we downloaded the exhaustive lists of cubic graphs from the House of Graphs [2], filtered the essentially 4-edge-connected bricks, and performed various computations using SageMath [25].

It should be noted that the class of essentially 4-edge-connected cubic graphs has been studied in the literature; however, perhaps not from the point of view of tight cuts, bricks and braces, and b -invariant edges. We mention a particular work of Wormald [27], wherein he proves a generation theorem for this class of graphs — that he refers to as ‘cyclically 4-connected cubic graphs’. Also, see Bondy and Murty [1, Exercise 9.4.7]. It would be

worth investigating whether Wormald’s generation theorem can be used to obtain simpler proofs for any of our results — especially, for the Main Theorem (19).

1.4 Organization and summary of this paper

In Section 2, we prove Theorem 8, which implies that every essentially 4-edge-connected cubic graph G is either a brick or a brace. The rest of this paper deals with the case in which G is a brick. In Section 3.1, we prove Theorem 16 which states that each edge is either removable or otherwise participates in a removable doubleton. In Section 3.2, we prove Theorem 17 which states that if e is a removable edge, then $b(G-e) \in \{1, 2\}$; and in Section 7, we demonstrate why such a result does not hold for cubic bricks, in general. The Main Theorem (19) is proved in Section 5, and it immediately implies Theorem 14 which states that if G is non-near-bipartite then at least two-third of its edges are b -invariant unless G is the Petersen graph.

Our Main Theorem (19) has some consequences pertaining to ‘Pfaffian orientations’ and the related notion of ‘conformal minors’. These topics are discussed in Section 4, and the relevant consequences of the Main Theorem are stated in Section 6.

2 Cubic graphs and tight cuts

In this section, our goal is to provide a graph-theoretical proof of Theorem 8. First, we need some easy facts pertaining to tight cuts.

Two cuts $C := \partial(X)$ and $D := \partial(Y)$ are said to be *crossing* if all four sets $X \cap Y$, $\bar{X} \cap Y$, $X \cap \bar{Y}$ and $\bar{X} \cap \bar{Y}$ are nonempty; otherwise C and D are said to be *laminar*. The following lemma is useful in proving theorems concerning matching covered graphs, and was used by Lovász [17] in the proof of Theorem 4.

Lemma 20. *Let G be a matching covered graph, and let $C := \partial(X)$ and $D := \partial(Y)$ be crossing tight cuts such that $|X \cap Y|$ is odd. Then:*

- (i) $I := \partial(X \cap Y)$ and $U := \partial(\bar{X} \cap \bar{Y})$ are both tight cuts,
- (ii) there are no edges between $\bar{X} \cap Y$ and $X \cap \bar{Y}$, and
- (iii) $|C| + |D| = |I| + |U|$. □

The following lemma immediately implies Corollary 7.

Lemma 21. *Let G be a matching covered graph that has a 2-separation $\{u, v\}$. If either of u and v is a cubic vertex then G has a barrier of cardinality two.*

Proof. As in the statement, let $\{u, v\}$ be a 2-separation of a matching covered graph G , and assume that v is a cubic vertex. If $G - u - v$ has an odd component then $\{u, v\}$ is a barrier. Now suppose that each component of $G - u - v$ is even. Since G is 2-connected, and since v is cubic, there exists a component L of $G - u - v$ such that v has exactly one neighbour, say w , that lies in L . Observe that $\{u, w\}$ is a barrier of G . □

We state an immediate consequence that will be useful later. (See Theorem 5.)

Corollary 22. *Let G be a bicritical graph. Then, for every 2-separation $\{u, v\}$, each of u and v is a non-cubic vertex. (In particular, if G is not a brick then G has at least two non-cubic vertices.)* \square

The graph, shown in Figure 1(b), is the smallest bicritical graph that is not a brick, and it has exactly two noncubic vertices.

The next fact is easily verified.

Lemma 23. *Let G be a cubic graph, and let $S \subseteq V(G)$. Then $|\partial(S)| \equiv |S| \pmod{2}$. Furthermore, if G is 2-edge-connected, then $|\partial(S)| \geq 2$ whenever $S \neq \emptyset$, and $|\partial(S)| \geq 3$ whenever $|S|$ is odd.* \square

Theorem 8 *In a cubic matching covered graph, each tight cut is a 3-cut.*

Proof. Let G be a cubic matching covered graph. We proceed by induction on $|V(G)|$. Every trivial cut is a 3-cut. Now let C denote a nontrivial tight cut.

By Corollary 7, G has a nontrivial tight cut D that is a barrier cut associated with some nontrivial barrier, say B . Since G is cubic and since B is a stable set, $|\partial(B)| = 3|B|$. Also, for each (odd) component J of $G - B$, we have that $|\partial(V(J))| \geq 3$. We infer that $|\partial(V(J))| = 3$ for each component J of $G - B$. Thus $|D| = 3$. In particular, every barrier cut is indeed a 3-cut. We may thus assume that C and D are distinct cuts.

It remains to deduce that $|C| = 3$. We consider two cases depending on whether C and D are laminar cuts, or whether they are crossing cuts.

First suppose that C and D are laminar cuts. Let G_1 and G_2 be the two D -contractions of G , and adjust notation so that C is a tight cut of G_1 . Since $|D| = 3$, it follows that G_1 is a cubic matching covered graph, whence by induction hypothesis $|C| = 3$.

Now suppose that C and D are crossing cuts. As in the statement of Lemma 20, we adjust notation so that $C := \partial(X)$ and $D := \partial(Y)$ and that $|X \cap Y|$ is odd. Then each of $I := \partial(X \cap Y)$ and $U := \partial(\overline{X} \cap \overline{Y})$ is a tight cut that is laminar with the cut D . From the preceding paragraph we infer that $|I| = |U| = 3$. By Lemma 20, we have that $|C| + |D| = |I| + |U|$, and thus $|C| = 3$. \square

3 Essentially 4-edge-connected cubic bricks

In the last section, we established that every essentially 4-edge-connected cubic graph is either a brick or a brace. Now we focus on the nonbipartite members of this class: bricks.

3.1 Removability

In this section, we present a proof of Theorem 16. We will use the following fact that is easily verified.

Lemma 24. *In a 3-connected graph, every nontrivial 3-cut is a matching.* □

In our attempts to prove the Main Theorem (19), we ran into a problem wherein we had to deal with a slightly more general class of cubic bricks (that includes the class of essentially 4-edge-connected cubic bricks). It is for this reason that we prove the following generalization of Theorem 16.

Theorem 25. *Let G be a cubic brick, and let e denote an edge that participates in every nontrivial 3-cut of G (if such cuts exist). Let f denote any edge that is adjacent with e . Then:*

- (i) *either f is removable, or*
- (ii) *or otherwise there exists a unique edge f' that depends on f , and $\{f, f'\}$ is a removable doubleton of G .*

In order to see why the above theorem implies Theorem 16, it suffices to note that if G is essentially 4-edge-connected then any edge may play the role of e in the statement of the above theorem.

Observe that, a staircase, as shown in Figure 2(b), is a cubic brick that is not essentially 4-edge-connected. However, each staircase has an edge that participates in every nontrivial 3-cut. On the other hand, the Tricorn, shown in Figure 2(a), has no such edge.

Proof of Theorem 25. Let v denote the common end of edges e and f . Suppose that f is not removable in G . That is, some edge depends on f . Our goal is to deduce that f participates in a removable doubleton.

Let f' denote any edge that depends on f . In what follows, we will show that $\{f, f'\}$ is a pair of mutually dependent edges; thus, by Corollary 11, f' is the unique edge that depends on f . Furthermore, since the dependence relation is transitive, no edge in the set $E(G) - f - f'$ depends on either of f and f' . Hence, $G - f - f'$ is matching covered and $\{f, f'\}$ is a removable doubleton of G . (Now, it remains to show that f depends on f' .)

Since f' depends on f , the edge f' is inadmissible in the matchable graph $G - f$. Applying Tutte's 1-factor Theorem, $G - f$ has a barrier B that contains both ends of f' . Let \mathcal{J} denote the set of odd components of $G - f - B$. Since G itself is free of nontrivial barriers, f must have its ends in distinct members of \mathcal{J} , say J_1 and J_2 . Adjust notation so that $v \in V(J_1)$. Observe that, for each $J \in \mathcal{J} - J_1$, the edge e does not lie in the cut $\partial(V(J))$.

Since G is 3-edge-connected, for each $J \in \mathcal{J}$, we have $|\partial(V(J))| \geq 3$. Since f has its ends in J_1 and in J_2 , there are at least $3|B| - 2$ edges that have one end in a member of \mathcal{J} , and the other end in B . Since G is cubic, and since f' has both ends in B , we infer that $|\partial(B)| \leq 3|B| - 2$. Thus there are exactly $3|B| - 2$ edges that have one end in a member of \mathcal{J} , and the other end in B . Consequently, for each $J \in \mathcal{J}$, we have $|\partial(V(J))| = 3$. Furthermore, $G - f - B$ has no even components. Since e participates in every nontrivial 3-cut of G , we conclude that every component of $G - f - B$, except perhaps J_1 , is trivial. We will now argue that J_1 is also trivial.

Suppose to the contrary that J_1 is nontrivial, whence $\partial(V(J_1))$ is a nontrivial 3-cut of G . Thus $e \in \partial(V(J_1))$. Note that $f \in \partial(V(J_1))$. Since e and f are adjacent, $\partial(V(J_1))$ is a nontrivial 3-cut that is not a matching. This contradicts Lemma 24.

In summary, each member of \mathcal{J} is trivial. Thus $G - f - f'$ is bipartite; one of its color classes is B which contains both ends of f' ; the other color class contains both ends of f . Clearly, f depends on f' . As discussed earlier, this completes the proof of Theorem 25. \square

The following is an easy application of Theorem 25, and it will be useful to us in the proof of the Main Theorem (19).

Corollary 26. *Let J be a cubic brick, and let xx' denote an edge that participates in every nontrivial 3-cut of J (if such cuts exist). Let $\partial(x) := \{e, d, f\}$ and let $\partial(x') := \{e, d', f'\}$. If either of d and d' depends on the other, or if either of f and f' depends on the other, then each of $\{d, d'\}$ and $\{f, f'\}$ is a removable doubleton of J . \square*

3.2 b -invariance and quasi- b -invariance

In this section, we will prove Theorem 17 which states that every removable edge of an essentially 4-edge-connected cubic brick G is either b -invariant or quasi- b -invariant. In fact, we will prove a stronger result that also describes the structure of G with respect to any given quasi- b -invariant edge. This will help us in proving the Main Theorem (19).

Before that, we need a few preliminary results. The following two statements are self-evident.

Lemma 27. *Let G be an essentially 4-edge-connected cubic graph, and let $\partial(X)$ be a 6-cut. If $G[X]$ is disconnected then $|X| = 2$. \square*

Lemma 28. *Let $\partial(X)$ be a 4-cut of an essentially 4-edge-connected cubic graph G . If there exist two edges in $\partial(X)$ that have a common end in X then $G[X]$ is isomorphic to K_2 . \square*

Recall that the tight cut decomposition of a bipartite matching covered graph yields only braces. In the same spirit, the following result from Lovász and Plummer [18, chapter 5], implies that the tight cut decomposition of a bicritical graph yields only bricks.

Proposition 29. *Let G be a bicritical graph, and let C denote a 2-separation cut. Then each C -contraction of G is also bicritical. \square*

A barrier B of a matching covered graph G is *special* if $G - B$ has precisely one nontrivial component.

Lemma 30. *Let e be a removable edge of an essentially 4-edge-connected cubic brick G , and let B denote a nontrivial barrier of $G - e$. Then B is special. Furthermore, $|\partial(V(J))| = 5$, where J denotes the unique nontrivial component of $G - e - B$.*

Proof. Since e is removable, $G - e$ is matching covered. Thus B is stable, and $G - e - B$ has no even components. Since G is cubic, $|\partial(B)| = 3|B|$.

We let \mathcal{J} denote the set of components of $G - e - B$. For each $J \in \mathcal{J}$, it follows from Lemma 23 that $|\partial(V(J))|$ is odd, and is at least 3. Also, since G itself is free of nontrivial barriers, e has its ends in distinct members of \mathcal{J} . From these facts, we infer that there exists a unique $J' \in \mathcal{J}$ such that $|\partial(V(J'))| = 5$, and for each $J \in \mathcal{J} - J'$, we have $|\partial(V(J))| = 3$. Since G is essentially 4-edge-connected, J' is the only nontrivial component of $G - e - B$. In particular, B is special, and this completes the proof of Lemma 30. \square

For a special barrier B of $G - e$, we let I denote the set of isolated vertices of $G - e - B$, and we let $X := B \cup I$. Note that, since B is special, $|I| = |B| - 1$. Often we may use subscripts or superscripts, or both, to denote a special barrier — for instance, B'_1 . In this case, the corresponding set of isolated vertices will be decorated similarly — that is, I'_1 — and likewise $X'_1 := B'_1 \cup I'_1$.

Lemma 31. *Let G be a bicritical graph, let $e := uv$ be a removable edge of G and let B denote a nontrivial special barrier of $G - e$. Assume that e has exactly one end, say v , in I . Then, for any distinct $y, z \in B$, the bipartite graph $G[X - v - y - z]$ is matchable. Furthermore, if $|B| \geq 3$, then the bipartite graph $G[X - v]$ is connected and is free of nontrivial 1-cuts.*

Proof. Note that the end u of edge e lies in the unique nontrivial component of $G - e - B$.

Let y and z denote distinct vertices in B . Observe that $G[X - v - y - z]$ has equicardinal color classes: $B - y - z$ and $I - v$. Since G is bicritical, $G - y - z$ has a perfect matching, say M . Since the neighbourhood of $I - v$ is a subset of B , the restriction of M to $G[X - v]$ is in fact a perfect matching of $G[X - v - y - z]$.

Now assume that $|B| \geq 3$, and let $H := G[X - v]$. Note that H is bipartite with color classes $I - v$ and B ; furthermore, $|B| = |I - v| + 2$. Observe that, in a bicritical graph, the neighbourhood of any (nonempty) stable set S has cardinality at least $|S| + 2$; in particular, this holds for each nonempty subset of $I - v$. These facts imply that H is connected. It remains to show that H is free of nontrivial 1-cuts.

Suppose, to the contrary, that $\{ab\}$ is a nontrivial 1-cut of H , where ab is an edge with $a \in I - v$ and $b \in B$. We let H_1 and H_2 denote the two (nontrivial) components of $H - ab$ such that $a \in V(H_1)$ and $b \in V(H_2)$. We let $k_1 := |V(H_1) \cap (I - v)|$ and $k_2 := |V(H_2) \cap (I - v)|$. It follows from the observations in the preceding paragraph that $|V(H_1) \cap B| \geq k_1 + 1$ and $|V(H_2) \cap B| \geq k_2 + 2$. Consequently, $|B| \geq k_1 + k_2 + 3 = |I - v| + 3$. This is a contradiction. Thus H is indeed free of nontrivial 1-cuts. This completes the proof of Lemma 31. \square

In order to prove Theorem 17, we need the Three Case Lemma, a result of Carvalho, Lucchesi and Murty [3] that plays an important role in a few of their works [4, 7, 8].

As we are dealing with cubic bricks, one of the cases of the lemma does not apply. So, in fact, the version of the lemma stated below has only two cases.

Lemma 32. *Let G be a bicritical graph and let e be a removable edge of G such that every barrier of $G - e$ is special. If $G - e$ is not bicritical then one of the following holds:*

- (i) *The graph $G - e$ has only one maximal nontrivial barrier, say B . The graph $(G - e)/X$ is bicritical, and e has at least one end in I .*
- (ii) *The graph $G - e$ has two maximal nontrivial barriers, say B and B^* . The set $B' := B^* - I$ is the unique maximal nontrivial barrier of $(G - e)/X$; furthermore, B' is a barrier of $G - e$ as well, and $I' = I^* - B$. The graph $((G - e)/X)/X'$ is bicritical, and the edge e has one end in I and the other end in I' . \square*

Now we are ready to prove the aforementioned strengthening of Theorem 17.

Theorem 33. *Let G be an essentially 4-edge-connected cubic brick, and let $e := uv$ denote a removable edge that is not b -invariant. Then, e is quasi- b -invariant. Moreover, the following properties hold:*

- (i) *The graph $G - e$ has two nontrivial special barriers, B and B' , such that at least one of them is a maximal barrier, the sets X and X' are disjoint, $v \in I$ and $u \in I'$, and the graph $H := (G - e)/(X \rightarrow x)/(X' \rightarrow x')$ is bicritical. (See Figure 5.)*
- (ii) *In H , each contraction vertex, x and x' , has degree exactly four; whereas every other vertex is cubic. Furthermore, $b(H) = b(G - e)$, and $\{x, x'\}$ is the unique 2-separation of H .*
- (iii) *The graph $H - x - x'$ has precisely two (even) components, L and L' . Each of x and x' has exactly two distinct neighbours in L , and likewise, in L' . Consequently, H is a simple graph, and each of B and B' is a maximal barrier of $G - e$. Furthermore, in G , the two edges joining L and X are nonadjacent; an analogous statement holds for L and X' , for L' and X , and for L' and X' .*
- (iv) *The graph H has two bricks; that is, $b(H) = 2$. Furthermore, the cubic graphs $J := H - L' + xx'$ and $J' := H - L + xx'$ are isomorphic to the underlying simple graphs of the two bricks of H .*
- (v) *Each of the four graphs $G[V(L) \cup X]$, $G[V(L') \cup X']$, $G[V(L') \cup X]$ and $G[V(L) \cup X']$ is nonbipartite.*
- (vi) *Every nontrivial 3-cut of J contains the edge xx' (if such cuts exist). An analogous statement holds for J' .*
- (vii) *If L is not isomorphic to K_2 , then $\partial(V(L))$ is a matching in G , and L is 2-connected. An analogous statement holds for L' .*

Proof. We will prove statements (i) to (vii) in order.

(i) Since $G - e$ has vertices of degree two, it is not bicritical. Also, by Lemma 30, every barrier of $G - e$ is special. We may thus invoke the Three Case Lemma (32).

First suppose that $G - e$ has only one maximal nontrivial barrier B , whence $H' := (G - e)/(X \rightarrow x)$ is bicritical, and the edge e has at least one end in I . Since H' is bicritical, each of its vertices has degree at least three, whence the edge e in fact has both ends in I . Note that $\partial(X)$ is a nontrivial tight cut of $G - e$, and the graph H' is one of the $\partial(X)$ -contractions of $G - e$. The other $\partial(X)$ -contraction of $G - e$ is bipartite, whence it does not yield any bricks. Thus $b(G - e) = b(H')$. Observe that each vertex of H' , except perhaps the contraction vertex x , is cubic. By Corollary 22, H' is in fact a brick. Thus $b(G - e) = b(H') = 1$. In other words, the edge e is b -invariant, contrary to our hypothesis.

It follows from the Three Case Lemma (32) that $G - e$ has two maximal nontrivial special barriers, say B and B^* . By Theorem 1, B and B^* are disjoint, whence I and I^* are disjoint. Furthermore, $B' = B^* - I$ is also a nontrivial special barrier of $G - e$, and $I' = I^* - B$. Consequently, X and X' are disjoint. Also, the graph $H := (G - e)/(X \rightarrow x)/(X' \rightarrow x')$ is bicritical, and the edge e has one end in I and the other end in I' . We may adjust notation so that $v \in I$ and $u \in I'$.

(ii) Observe that \bar{X} is precisely the vertex set of the unique nontrivial component of $G - e - B$. We let $C := \partial(X)$. By Lemma 30, $|C| = 5$. Likewise, $|C'| = 5$, where $C' := \partial(X')$. Since e has one end in I and the other end in I' , and since X and X' are disjoint, $e \in C \cap C'$. Observe that, in $G - e$, the cuts $C - e$ and $C' - e$ are laminar nontrivial tight cuts, and H is obtained by shrinking their disjoint shores, X and X' , to single vertices x and x' , respectively. Since $|C - e| = |C' - e| = 4$, each of the contraction vertices x and x' has degree exactly four in H . Clearly, every other vertex of H is cubic. Furthermore, each of $(G - e)/\bar{X}$ and $(G - e)/\bar{X}'$ is bipartite; whence they do not yield any bricks. Thus, $b(H) = b(G - e)$.

Since e is not b -invariant, H is not a brick. However, H is bicritical. By invoking Theorem 5 and Corollary 22, we conclude that $\{x, x'\}$ is the unique 2-separation of H .

(iii) Since H is bicritical, each component of $H - x - x'$ is even. Let L and L' denote two distinct components of $H - x - x'$. As H is 2-connected, x has at least one neighbour in L , say w . If w is the only neighbour of x in L then $\{w, x'\}$ is a barrier in H , contradicting the fact that H is bicritical. Thus, x has at least two neighbours in L . Likewise, x has at least two neighbours in L' . Since x has degree exactly four in H , we infer that L and L' are the only components of $H - x - x'$, and that x has exactly two neighbours in L , and likewise, x has exactly two neighbours in L' . A similar conclusion holds for the vertex x' . These facts imply that H is in fact a simple graph.

As noted earlier, in the proof of (i), B is a maximal nontrivial barrier of $G - e$, and B' is a subset of the maximal nontrivial barrier B^* . Furthermore, $B^* \subseteq B' \cup I$ and $I^* \subseteq I' \cup B$, whence $X^* \subseteq X \cup X'$. Suppose that B' is a proper subset of B^* , whence $|B^*| \geq 3$. By Lemma 31, the subgraph $G[X^* - u]$ is connected; its vertex set meets each of the sets $X' - u$ and X ; however, G has no edges joining these sets. This is absurd. We thus conclude that $B' = B^*$. In other words, B' is in fact a maximal barrier of $G - e$.

Now, consider the two edges joining X and L , say d and f . We have already established that H is simple; in particular, d and f do not share a common end in L . Observe that

$\partial(V(L))$ is a 4-cut in G . Also, the shore $\overline{V(L)}$ is clearly not isomorphic to K_2 . By Lemma 28, d and f do not share a common end in X . In other words, d and f are nonadjacent.

(iv) We consider a 2-separation cut of H associated with its only 2-separation $\{x, x'\}$, say $D := \partial_H(V(L) \cup \{x\})$. Observe that the underlying simple graph of one of the two D -contractions of H is isomorphic to $J := H - L' + xx'$, and that the underlying simple graph of the other D -contraction is isomorphic to $J' := H - L + xx'$. Thus, $b(G - e) = b(H) = b(J) + b(J')$. Since H is bicritical, Proposition 29 implies that each of J and J' is bicritical; observe that each of them is cubic. Corollary 22 implies that each of J and J' is in fact a brick. Thus $b(G - e) = b(H) = 2$. In particular, e is a quasi- b -invariant edge of G .

(v) As noted above, $D := \partial_H(V(L) \cup \{x\})$ is a nontrivial tight cut of H . Thus, D is a nontrivial tight cut of $G - e$ as well, and its shores are $V(L) \cup X$ and $V(L') \cup X'$. Each D -contraction of $G - e$ is a matching covered graph that has exactly one brick; in particular, each D -contraction is nonbipartite. Thus, each shore of D induces a nonbipartite subgraph. An analogous argument shows that each of $G[V(L') \cup X]$ and $G[V(L) \cup X']$ is also nonbipartite.

(vi) Let F denote any cut of J such that $xx' \notin F$. Then F has a shore that is disjoint with $\{x, x'\}$, whence F is a cut of G as well. Since G is essentially 4-edge-connected, F is a 3-cut if and only if F is trivial. Consequently, every nontrivial 3-cut of J contains the edge xx' .

(vii) As noted earlier, $\partial(V(L))$ is a 4-cut of G . It follows from statement (iii) that, for any two edges in $\partial(V(L))$, their ends in $\overline{V(L)}$ are distinct. If L is not isomorphic to K_2 , then Lemma 28 implies that, for any two edges in $\partial(V(L))$, their ends in $V(L)$ are also distinct, whence $\partial(V(L))$ is indeed a matching in G .

Now, suppose that L is not isomorphic to K_2 . Assume, to the contrary, that L is not 2-connected, and let w denote a cut-vertex of L . Let L_1 and L_2 denote distinct components of $L - w$. For $i \in \{1, 2\}$, let $F_i := \partial(V(L_i))$. Then $F_1 \cup F_2 \subseteq \partial(w) \cup \partial(V(L))$. Since F_1 and F_2 are disjoint, $|F_1| + |F_2| \leq |\partial(w)| + |\partial(V(L))| = 7$. Thus, at least one of F_1 and F_2 is a 3-cut in G . Adjust notation so that F_1 is a 3-cut. Clearly, the edge xx' does not lie in F_1 . Thus F_1 is a 3-cut in J . It follows from statement (vi) that F_1 is a trivial cut of J . However, since $F_1 \subseteq \partial(w) \cup \partial(V(L))$, we infer that two edges of $\partial(V(L))$ share a common end in $V(L)$, contradicting what we have established in the preceding paragraph. We thus conclude that if L is not isomorphic to K_2 then L is indeed 2-connected.

This completes the proof of Theorem 33. □

We conclude this section with an easy lemma — that will be very useful in proving the Main Theorem (19). It appears implicitly and crucially in the proof of the main result of Carvalho, Lucchesi and Murty [7]; we include their proof for the sake of completeness.

Lemma 34. *Let G be a bicritical graph, and let e_1 and e_2 be two adjacent edges. If B_1 is a barrier of $G - e_1$, and if B_2 is a barrier of $G - e_2$, then $|B_1 \cap B_2| \leq 1$.*

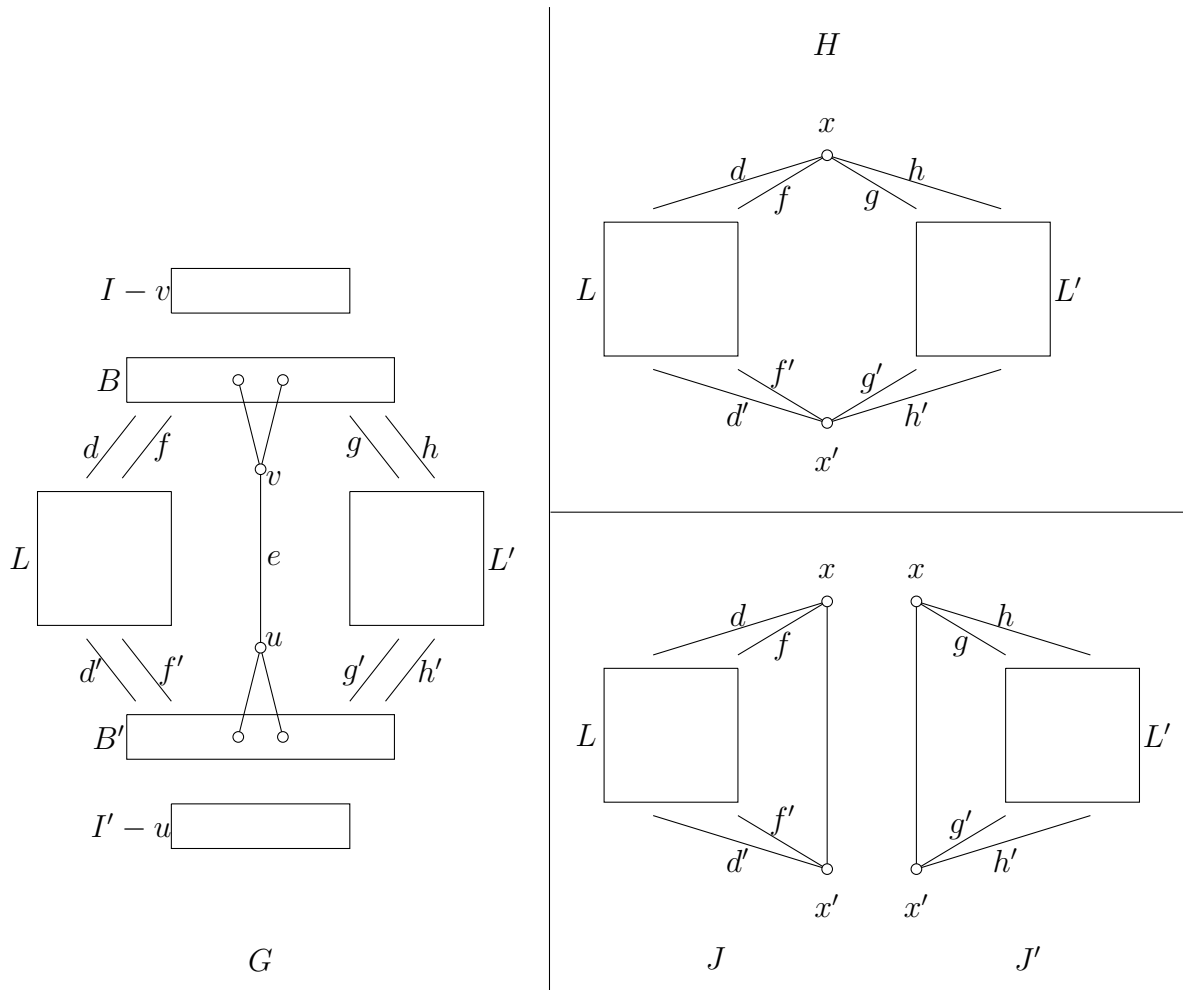

Figure 5: (left) An essentially 4-edge-connected cubic brick G with a quasi- b -invariant edge $e := vu$; (top right) bicritical graph H obtained from $G - e$; (bottom right) cubic bricks J and J' obtained from H

Proof. Suppose to the contrary that $B_1 \cap B_2$ contains two distinct vertices s and t . Since G is bicritical, let M denote a perfect matching of $G - s - t$. Since $s, t \in B_1$, the graph $G - e_1 - s - t$ has no perfect matching, whence $e_1 \in M$. Likewise, we infer that $e_2 \in M$. This is absurd since e_1 and e_2 are adjacent edges. Thus, $|B_1 \cap B_2| \leq 1$. \square

3.3 Matchable subgraphs

In the proof of the Main Theorem (19), we will often need to construct perfect matchings of certain subgraphs of the brick under consideration. In this section, we prove some technical lemmas that will help us in constructing the desired perfect matchings.

Before that, we state two results concerning bipartite matchable graphs that may be easily derived from Hall's Theorem. These will be invoked only in the proof of Lemma 40.

Proposition 35. Let $H[A, B]$ denote a bipartite matchable graph. Then H is matching covered if and only if $H - a - b$ is matchable for each pair of vertices $a \in A$ and $b \in B$. \square

Proposition 36. Let $H[A, B]$ denote a bipartite matchable graph. If an edge ab is inadmissible then there exist partitions $[A_1, A_2]$ of A and $[B_1, B_2]$ of B such that $a \in A_2$, $b \in B_1$, $|A_1| = |B_1|$ and that there are no edges from A_1 to B_2 . \square

Now let $e := uv$ denote a quasi- b -invariant edge of an essentially 4-edge-connected cubic brick G . We invoke Theorem 3.7, and adopt all of the notation therein (pertaining to the structure of G with respect to e), as well as the following notation. (See Figure 5.)

Notation 37. Let $\partial(V(L)) := \{d, f, d', f'\}$, where each of d and f has one end in X , and each of d' and f' has one end in X' . Likewise, let $\partial(V(L')) := \{g, h, g', h'\}$, where each of g and h has one end in X , and each of g' and h' has one end in X' .

The next three lemmas will help us in constructing perfect matchings of certain subgraphs with the additional property that a specified edge is included.

Lemma 38. Let p and q denote distinct vertices of L , and let $e' \in \partial(v) - e$. If $L - p - q$ is matchable then e' is admissible in $G - p - q$.

Proof. Let y denote the end of e' in B . So $e' = vy$. By Theorem 33(iii), g and h are nonadjacent edges, whence at least one of them, say g , is not in $\partial(y)$. We let z denote the end of g in B . (Thus $y \neq z$.) Now, let M' be a perfect matching of the brick J' such that $g \in M'$. Clearly, M' contains exactly one of g' and h' . Adjust notation so that $g' \in M'$, and let z' denote the end of g' in B' . The vertex u has two distinct neighbours in B' , and we let $y' \in B'$ denote a neighbour of u that is distinct from z' .

We now invoke Lemma 31 twice. The graph $G[X - v - y - z]$ has a perfect matching, say N . Likewise, $G[X' - u - y' - z']$ has a perfect matching, say N' . By hypothesis, $L - p - q$ has a perfect matching, say M . Observe that $M \cup M' \cup N \cup N' \cup \{vy, uy'\}$ is a perfect matching of $G - p - q$ that contains the edge e' , as desired. \square

Lemma 39. Let p and q denote distinct vertices of L , let M be a perfect matching of $J - p - q$, and let M' be a perfect matching of J' . Suppose that $M \cup M'$ does not contain the edge xx' , and that $M \cup M'$ is a matching in G . Then $M \cup M' \cup \{e\}$ may be extended to a perfect matching of $G - p - q$.

Proof. Note that $xx' \notin M \cup M'$. Thus M contains precisely one edge incident with x , and it contains precisely one edge incident with x' . An analogous statement holds for M' . By hypothesis, $M \cup M'$ is a matching in G . We let y and z denote the two distinct vertices of X that are incident with edges in $M \cup M'$. Likewise, we let y' and z' denote the two distinct vertices of X' that are incident with edges in $M \cup M'$.

We now invoke Lemma 31 twice. The graph $G[X - v - y - z]$ has a perfect matching, say N . Likewise, $G[X' - u - y' - z']$ has a perfect matching, say N' . Observe that $M \cup M' \cup \{e\} \cup N \cup N'$ is a perfect matching of $G - p - q$. This completes the proof. \square

Lemma 40. *Suppose that $\{d, d'\}$ is a removable doubleton of J . Let $d := xy$, and let $[T, T']$ denote the bipartition of $J - d - d'$ such that $x, y \in T$. Then, for each $p \in T' - x'$, the edge xx' is admissible in the bipartite graph $J - d - d' - p - y$.*

Proof. Since $J - d - d'$ is bipartite and matching covered, Proposition 35 implies that $J - d - d' - p - y$ is matchable, and it is bipartite with color classes $T - y$ and $T' - p$.

Suppose that xx' is inadmissible in $J - d - d' - p - y$. By Proposition 36, there exist partitions $[T_1, T_2]$ of $T - y$ and $[T'_1, T'_2]$ of $T' - p$ such that $x \in T_1$, $x' \in T'_2$, $|T_1| = |T'_1|$, and that there are no edges between T'_1 and T_2 . Since $d = xy$ and $x \in T_1$, no end of d is in T_2 . Thus, in J , each neighbour of T_2 lies in $T'_2 \cup \{p\}$, whence J has a nontrivial barrier, contradiction. We conclude that xx' is indeed admissible in $J - d - d' - p - y$. \square

3.4 Bricks of order 10

In this section, we describe the essentially 4-edge-connected cubic bricks, up to order 10, that have a quasi- b -invariant edge. It is an easy application of Theorem 33.

Let G be an essentially 4-edge-connected cubic brick that has a quasi- b -invariant edge $e := \{u, v\}$. We invoke Theorem 33, and adopt all of the notation therein regarding the structure of G with respect to edge e . See Figure 5. Note that each of the sets $B, B', V(L)$ and $V(L')$ has at least two vertices. Since these sets are pairwise-disjoint, and since none of them meets $\{u, v\}$, the graph G has at least 10 vertices.

Now suppose that $|V(G)| = 10$, whence each of the sets $B, B', V(L)$ and $V(L')$ is a doubleton. Furthermore, each of L and L' is isomorphic to K_2 , and each of $G[X]$ and $G[X']$ is a path of order 3. By Theorem 33(iii), each of $\{d, f\}$, $\{d', f'\}$, $\{g, h\}$ and $\{g', h'\}$ is a pair of nonadjacent edges. Consequently, the graph shown in Figure 6(a) is a subgraph of G .

Clearly, there are exactly two possibilities now. Either G is the Petersen graph, that has girth 5, as shown in Figure 6(b). Otherwise, G is the graph shown in Figure 6(c), that has girth 4; we shall refer to this graph as *Petersen's Mate*.

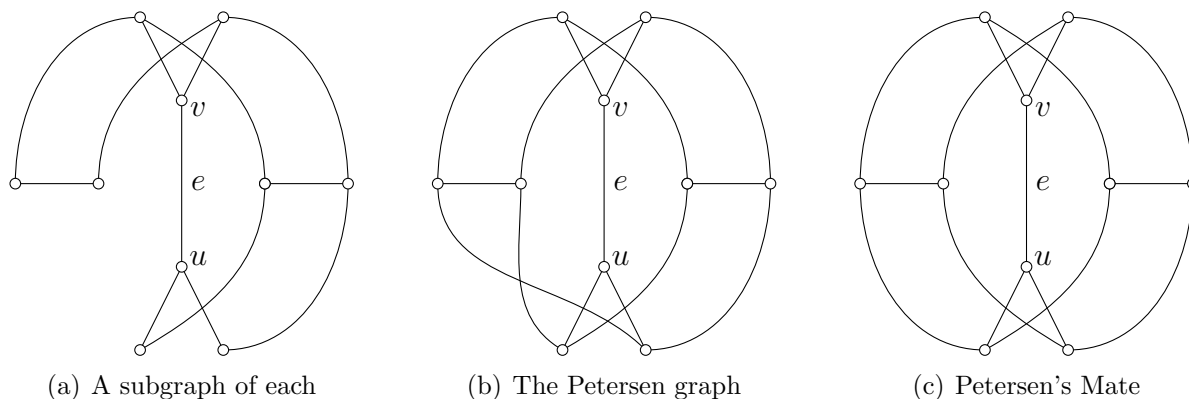

Figure 6: Bricks of order 10

Since the Petersen graph is edge-transitive, each of its edges is quasi- b -invariant. On the other hand, the reader may verify that Petersen's Mate has exactly four edge-orbits: the edge e is the only quasi- b -invariant edge, each edge adjacent with e participates in a removable doubleton, and members of the remaining two edge-orbits are b -invariant. We will find these facts, summarized below, useful in the proof of the Main Theorem (19).

Proposition 41. *There exist precisely two essentially 4-edge-connected cubic bricks, of order at most 10, that have a quasi- b -invariant edge. These are the Petersen graph and Petersen's Mate. Furthermore, each edge of the Petersen graph is quasi- b -invariant; whereas, Petersen's Mate has a unique quasi- b -invariant edge. \square*

4 Pfaffian graphs and conformal minors

In this section, we discuss two related concepts: 'Pfaffian orientations' and 'conformal minors'. We will use Lemma 43 in the proof of the Main Theorem (19); the reader may postpone reading the rest until before Section 6.

Let D be an orientation of an undirected graph G . For an even cycle C of G , we abuse notation and use C to also refer to the corresponding set of arcs in D . Note that regardless of the sense of traversal of C , the number of forward arcs and the number of reverse arcs have the same parity. We say that C is *evenly-oriented* if the number of forward arcs is even, and *oddly-oriented* otherwise.

Let G be a matchable graph. A cycle C of a graph G is *conformal* if $G - V(C)$ is matchable. An orientation D (of G) is *Pfaffian* if each conformal cycle is oddly-oriented. Furthermore, we say that G is a *Pfaffian* graph if G admits a Pfaffian orientation; otherwise G is *non-Pfaffian*.

The significance of Pfaffian orientations arises from the fact that if a graph is Pfaffian then the number of its perfect matchings may be computed in polynomial-time. We may thus restrict ourselves to matching covered graphs. Kasteleyn [11] showed that all planar graphs are Pfaffian. However, the Pfaffian graph recognition problem remains unsolved for nonplanar graphs.

Problem 42. Characterize Pfaffian nonplanar matching covered graphs. (Is the problem of deciding whether a given graph is Pfaffian in the complexity class \mathcal{NP} ? Is it in \mathcal{P} ?)

The smallest non-Pfaffian graph is $K_{3,3}$. We now describe a certificate that may be used to prove that certain graphs are non-Pfaffian. It should be noted that this certificate does not exist in every non-Pfaffian graph. For instance, the Petersen graph is non-Pfaffian; see [8]. However, it does not contain the certificate we are about to describe.

To *bi-subdivide an edge e* means to subdivide e by inserting an even number of vertices; or equivalently, to replace e by an odd path. A *bi-subdivision* of a graph J is a graph H obtained from J by means of bi-subdividing a subset of its edges. For a matchable graph G , we say that a subgraph H is a *rigid bi-subdivision of $K_{2,3}$* if it satisfies the following properties:

- the subgraph H is a bi-subdivision of $K_{2,3}$ and
- each cycle of H is conformal in G .

Lemma 43. *Every matchable graph that has a rigid bi-subdivision of $K_{2,3}$ is non-Pfaffian.*

Proof. Let G be a matchable graph, and let H denote a subgraph that is a rigid bi-subdivision of $K_{2,3}$. Note that H has two cubic vertices, say u and v ; and it has three edge-disjoint uv -paths, each of even length, say, P_1, P_2 and P_3 . Let D denote any orientation of G . We will argue that D is not a Pfaffian orientation.

For $i, j \in \{1, 2, 3\}$, such that $i < j$, let $C_{i,j}$ denote the (even) cycle $P_i \cup P_j$, and let $l_{i,j}$ denote the number of forward arcs in $C_{i,j}$ — traversing P_i from u to v , and P_j from v to u . Since H is rigid, each of $C_{1,2}, C_{2,3}$ and $C_{1,3}$ is a conformal cycle of G .

Observe that each edge of the path P_2 is a forward arc for exactly one of $C_{1,2}$ and $C_{2,3}$. Consequently, $l_{1,3} = l_{1,2} + l_{2,3} - |P_2|$. Since P_2 is of even length, $l_{1,3} \equiv l_{1,2} + l_{2,3} \pmod{2}$. It follows that at least one of the (conformal) cycles $C_{1,2}, C_{2,3}$ and $C_{1,3}$ is evenly-oriented. Thus D is not a Pfaffian orientation, whence G is non-Pfaffian. \square

We will find the above lemma useful in the proof of the Main Theorem (19). Now we discuss another concept that is intrinsically related to Pfaffian graphs.

Let G be a matching covered graph. A subgraph H of G is *conformal* if $G - V(H)$ is matchable. Observe that G is Pfaffian if and only if each conformal matching covered subgraph of G is Pfaffian.

Now, let J be a cubic matching covered graph. We say that J is a *conformal minor* of a matching covered graph G if the latter has a conformal subgraph H that is a bi-subdivision of J . For the sake of brevity, we say that G is *J -based* if the latter is a conformal minor of the former; otherwise we say that G is *J -free*. The following fundamental result was proved by Little [14].

Theorem 44. *A bipartite matching covered graph is Pfaffian if and only if it is $K_{3,3}$ -free.*

It was shown by Little and Rendl [15] that a matching covered graph is Pfaffian if and only if each of its bricks and braces is Pfaffian. Consequently, it suffices to solve Problem 42 for bricks and braces. In particular, for the case of bipartite graphs, it suffices to characterize the $K_{3,3}$ -free braces; this feat was accomplished by Robertson, Seymour and Thomas [24], and independently by McCuaig [21]; their works yield a polynomial-time algorithm to decide whether a given bipartite graph is Pfaffian or not.

Thus, in order to solve Problem 42, one may restrict their attention to nonplanar and nonbipartite matching covered graphs, and in particular to nonplanar bricks.

A result similar to Theorem 44 was proved for near-bipartite graphs by Fischer and Little [10]. In particular, they proved that a near-bipartite matching covered graph is Pfaffian if and only if it does not contain any of seven cubic graphs as a conformal minor; three of these graphs are $K_{3,3}$, Cubplex and Twinplex; the remaining four are obtained from these three by replacing at most one or two (specific) vertices by triangles. Also,

Miranda and Lucchesi [22] gave a polynomial-time algorithm to decide whether a given near-bipartite graph is Pfaffian or not; their algorithm does not rely on the result of Fischer and Little. Thus one may further restrict attention to the non-near-bipartite bricks.

Problem 45. Characterize Pfaffian nonplanar non-near-bipartite bricks.

Now we turn our attention to the following fundamental result of Lovász [16] — that has nothing to do with Pfaffian orientations.

Theorem 46. *Every nonbipartite matching covered graph is either K_4 -based, or is $\overline{C_6}$ -based, or both.*

This gives rise to two natural problems.

Problem 47. Characterize K_4 -free matching covered graphs.

Problem 48. Characterize $\overline{C_6}$ -free matching covered graphs.

The following result of Kothari and Murty [12] shows that, for both problems stated above, one may restrict their attention to bricks.

Theorem 49. *Let J denote any cubic brick. A matching covered graph G is J -free if and only if each of its bricks is J -free.*

In the same work [12], they solved both problems when the graph under consideration is a planar brick. However, these problems remain unsolved for nonplanar bricks.

Problem 50. Characterize K_4 -free nonplanar bricks.

Problem 51. Characterize $\overline{C_6}$ -free nonplanar bricks.

It should be noted that, unlike the Pfaffian graph recognition problem, Problems 50 and 51 are unsolved even for the restricted case of near-bipartite graphs.

Another important and related problem is that of deciding whether or not a given matching covered graph G is solid. Carvalho, Lucchesi and Murty [6] showed that G is solid if and only if each of its bricks is solid. Thus, as usual, one may restrict attention to bricks. The same authors, in [7], proved that the only planar solid bricks are the odd wheels. Thus it remains to solve the problem for nonplanar bricks.

Problem 52. Characterize solid nonplanar bricks.

Recently, Lucchesi, Carvalho, Kothari and Murty [20] showed that Problems 51 and 52 are in fact equivalent.

Theorem 53. *A nonplanar brick G is solid if and only if it is $\overline{C_6}$ -free unless G is the Petersen graph (up to multiple edges).*

The Petersen graph is $\overline{C_6}$ -free but it is not solid.

5 Proof of the Main Theorem

Our goal is to prove the Main Theorem (19). We adopt the following notation.

Notation 54. Let G be an essentially 4-edge-connected cubic brick, let $v \in V(G)$, and let e_1, e_2, e_3 be the three edges incident with v . For each $i \in \{1, 2, 3\}$, we let $e_i := vu_i$, and we let s_i and t_i denote the two neighbours of u_i that are distinct from v .

For $i \in \{1, 2\}$, we assume that e_i is quasi- b -invariant, and we adopt the notation and conventions introduced in Theorem 33 and Notation 37 — with the only difference being that all of the notation (except for the vertex v) is decorated with subscript i . For instance, the two (nontrivial) barriers of $G - e_i$ will be denoted as B_i and B'_i with the convention that the two neighbours of v , that are distinct from u_i , lie in the barrier B_i . Thus $s_i, t_i \in B'_i$.

Note that $u_2, u_3 \in B_1$, and that L_1 and L'_1 are the two components of $G - X_1 - X'_1$. It follows from Theorem 33(iii) that each of u_2 and u_3 has at most one neighbour in $V(L_1)$, and likewise, at most one neighbour in $V(L'_1)$. Analogously, each of u_1 and u_3 has at most one neighbour in $V(L_2)$, and likewise, at most one neighbour in $V(L'_2)$. These observations, and associated notational conventions, are stated below.

Notation 55. For each $i \in \{1, 2\}$, and for each $j \in \{1, 2, 3\}$, where $i \neq j$, each of the sets $V(L_i) \cap \{s_j, t_j\}$ and $V(L'_i) \cap \{s_j, t_j\}$ is either empty or a singleton; furthermore, if the former set is a singleton we let s_j denote its unique element, and if the latter set is a singleton we let t_j denote its unique element.

For instance, if the set $\{s_1, t_1\}$ has nonempty intersection with each of $V(L_2)$ and $V(L'_2)$ then, as per above convention, $s_1 \in V(L_2)$ and $t_1 \in V(L'_2)$.

5.1 The barriers B_1 and B_2

As a first step, we proceed to show that at least one of the two sets B_1 and B_2 is a doubleton. (Eventually, we will establish that each of them is a doubleton.)

Proposition 56. *At least one of the two sets B_1 and B_2 is a doubleton.*

Proof. We begin by noting that $u_3 \in B_1 \cap B_2$ and that $N(u_3) = \{v, s_3, t_3\}$. By Lemma 34, we infer that $B_1 \cap B_2 = \{u_3\}$, and this immediately implies $I_1 \cap I_2 = \{v\}$.

Now suppose that each of B_1 and B_2 has cardinality at least three. Since $|B_1| \geq 3$, the vertex u_3 must have a neighbour in $I_1 - v$, otherwise $B_1 - u_3$ is a nontrivial barrier in G . Likewise, u_3 must have a neighbour in $I_2 - v$. These facts imply that the set $\{s_3, t_3\}$ meets each of I_1 and I_2 . Since $I_1 \cap I_2 = \{v\}$, exactly one of s_3 and t_3 lies in I_1 and the other lies in I_2 . Adjust notation so that $s_3 \in I_1$ and $t_3 \in I_2$. Consequently, as per Notation 55, $t_3 \in V(L'_1)$. By Theorem 33(vii), t_3 has a neighbour, say p , in L'_1 . Since $t_3 \in I_2$, we infer that $p \in B_2$. As B_2 is a barrier of $G - e_2$, it follows that the graph $G - e_2 - u_3 - p$ is not matchable. In the next two paragraphs, we will contradict this fact by constructing a perfect matching of $G - e_2 - u_3 - p$.

Let M' be a perfect matching of $J'_1 - p - x_1$. Note that M' contains exactly one of g'_1 and h'_1 . Adjust notation so that $g'_1 \in M'$, and let z' denote the end of g'_1 in B'_1 . By Theorem 33(iii), d'_1 and f'_1 are nonadjacent, whence at least one of them is not incident with z' . Adjust notation so that $f'_1 \notin \partial(z')$, and let y' denote the end of f'_1 in B'_1 . Thus $y' \neq z'$. Now, let M be a perfect matching of J_1 such that $f_1 \in M$. Exactly one of d_1 and g_1 lies in M . Adjust notation so that $g_1 \in M$ and let y denote the end of g_1 in B_1 . Note that two neighbours of u_3 lie in I_1 , whereas the third neighbour lies in L'_1 . Thus $u_3 \neq y$.

Now we invoke Lemma 31 twice. Let N be a perfect matching of $G[X_1 - v - u_3 - y]$, and let N' be a perfect matching of $G[X'_1 - u_1 - y' - z']$. Observe that $M \cup M' \cup N \cup N' \cup \{e_1\}$ is indeed a perfect matching of $G - e_2 - u_3 - p$. This contradicts what we have established earlier. We thus conclude that at least one of B_1 and B_2 has cardinality precisely two, and this completes the proof of Proposition 56. \square

We adjust notation so that $B_1 = \{u_2, u_3\}$, whence $I_1 = \{v\}$. Consequently, as per the conventions stated in Notation 55, vertices s_2 and s_3 lie in L_1 , and t_2 and t_3 lie in L'_1 . We adjust notation so that $d_1, g_1 \in \partial(u_2)$ and $f_1, h_1 \in \partial(u_3)$. See Figure 7. Note that, among other things, Theorem 33(iii) implies that all of the six vertices $s_1, t_1, s_2, t_2, s_3, t_3$ are pairwise distinct, whence G has order at least 10.

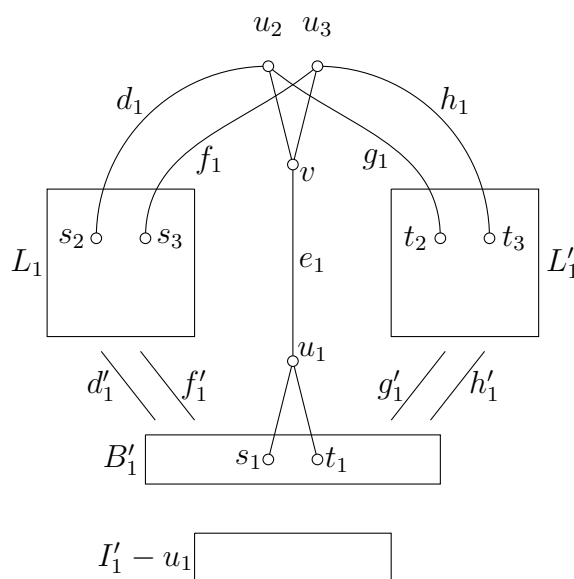

Figure 7: The set B_1 is a doubleton

5.2 Bricks isomorphic to K_4

Let $\mathcal{J} := \{J_1, J'_1, J_2, J'_2\}$, and let $\mathcal{L} := \{L_1, L'_1, L_2, L'_2\}$. Observe that a brick $J \in \mathcal{J}$ is isomorphic to K_4 (up to multiple edges) if and only if the corresponding (connected) graph $L \in \mathcal{L}$ is isomorphic to K_2 . Our next goal is to prove that each member of \mathcal{J}

is isomorphic to K_4 (up to multiple edges)¹. However, to do so, we will require several auxiliary lemmas.

By assuming that the set B_1 is a doubleton, we have lost the symmetry between edges e_1 and e_2 . We will thus find it convenient to first prove that each of J_1 and J'_1 is isomorphic to K_4 . The following lemma shows why doing so is in fact sufficient.

Lemma 57. *If $J_1 \simeq K_4$ then $J_2 \simeq K_4$ and $V(L_1) \cap V(L_2) = \{s_3\}$. Likewise, if $J'_1 \simeq K_4$ then $J'_2 \simeq K_4$ and $V(L'_1) \cap V(L'_2) = \{t_3\}$.*

Proof. By symmetry, it suffices to prove the first statement. Assume that $J_1 \simeq K_4$, whence $E(L_1) = \{s_2s_3\}$. Observe that s_3 is a common neighbour of $u_3 \in B_2$ and $s_2 \in B'_2$. Consequently, $s_3 \in V(L_2) \cup V(L'_2)$, and as per Notation 55, $s_3 \in V(L_2)$. Now, since $\partial(V(L_2))$ is not a matching, Theorem 33(vii) implies that $L_2 \simeq K_2$, whence $J_2 \simeq K_4$. Note that $V(L_1) \cap V(L_2) = \{s_3\}$. This completes the proof of Lemma 57. \square

Corollary 58. *If at least one of J_1 and J'_1 is isomorphic to K_4 , and if the set B'_1 is a doubleton, then G is the Petersen graph.*

Proof. Assume that J_1 is isomorphic to K_4 and that $|B'_1| = 2$. Since $J_1 \simeq K_4$, Lemma 57 implies that $J_2 \simeq K_4$ and $V(L_1) \cap V(L_2) = \{s_3\}$. There are two edges joining the sets $B'_1 = \{s_1, t_1\}$ and $V(L_1) = \{s_2, s_3\}$. Consequently, one of s_1 and t_1 lies in $V(L_2)$, and as per Notation 55, $E(L_2) = \{s_1s_3\}$. Thus, $t_1s_2 \in E(G)$, whence t_1 is a common neighbour of $u_1 \in B_2$ and $s_2 \in B'_2$. It follows that $t_1 \in V(L'_2)$, and since $\partial(V(L'_2))$ is not a matching, Theorem 33(vii) implies that $L'_2 \simeq K_2$. Now, we observe that u_1 has no neighbours in $I_2 - v$, and that s_2 has no neighbours in $I'_2 - u_2$. By Lemma 31, $B_2 = \{u_1, u_3\}$ and $B'_2 = \{s_2, t_2\}$. Consequently, $t_2s_1 \in E(G)$, and each of u_3 and t_2 is adjacent with the unique vertex in $V(L'_2) - t_1$. As per Notation 54, $V(L'_2) = \{t_1, t_3\}$; whence $t_1t_3, t_2t_3 \in E(G)$. We now have a cubic subgraph of G that is isomorphic to the Petersen graph. Thus G is indeed the Petersen graph. \square

Corollary 59. *If at least one of J_1 and J'_1 is isomorphic to K_4 , and if the set B'_2 is a doubleton, then G is the Petersen graph.*

Proof. Assume that J_1 is isomorphic to K_4 and that $|B'_2| = 2$. Since $J_1 \simeq K_4$, Lemma 57 implies that $J_2 \simeq K_4$ and $V(L_1) \cap V(L_2) = \{s_3\}$. Since $B'_2 = \{s_2, t_2\}$, and $s_2s_3 \in E(G)$, the unique vertex in $V(L_2) - s_3$ is a common neighbour of t_2 and s_3 . Consequently, $\partial(V(L'_1))$ is not a matching; by Theorem 33(vii), $E(L'_1) = \{t_2t_3\}$ and $J'_1 \simeq K_4$. Lemma 57 implies that $J'_2 \simeq K_4$ and $V(L'_1) \cap V(L'_2) = \{t_3\}$. Now, observe that u_3 has no neighbours in $I_2 - v$, whence it follows from Lemma 31 that $B_2 = \{u_1, u_3\}$. Consequently, $s_1, t_1 \in V(L_2) \cup V(L'_2)$, and as per Notation 55, $s_1 \in V(L_2)$ and $t_1 \in V(L'_2)$. In particular, $s_1s_3, t_1t_3 \in E(G)$. Finally, note that $s_2t_1 \in E(G)$. We now have a cubic subgraph of G that is isomorphic to the Petersen graph. Thus G is indeed the Petersen graph. \square

¹From now on, we shall abuse terminology slightly and just write ‘isomorphic to K_4 ’ instead of writing ‘isomorphic to K_4 (up to multiple edges)’.

We now embark on the arduous journey of proving that each of the bricks J_1 and J'_1 is indeed isomorphic to K_4 .

Lemma 60. *If $V(L_1) \cap (B_2 \cup B'_2) = \{s_2\}$ then $J_1 \simeq K_4$. Likewise, if $V(L'_1) \cap (B_2 \cup B'_2) = \{t_2\}$ then $J'_1 \simeq K_4$.*

Proof. By symmetry, it suffices to prove the first statement. Assume, to the contrary, that $V(L_1) \cap (B_2 \cup B'_2) = \{s_2\}$ and that J_1 is not isomorphic to K_4 . By Theorem 33(vii), L_1 is a 2-connected graph, whence each of its vertices has at least two distinct neighbours. This fact, along with the hypothesis $V(L_1) \cap (B_2 \cup B'_2) = \{s_2\}$, implies that $V(L_1) \cap (I_2 \cup I'_2) = \emptyset$. Thus $V(L_1) \cap (X_2 \cup X'_2) = \{s_2\}$. Consequently, $L_1 - s_2$ is a connected subgraph of $G - X_2 - X'_2$, whence it is either a subgraph of L_2 or of L'_2 . Since $s_3 \in V(L_1)$, as per Notation 55, $L_1 - s_2$ is a subgraph of L_2 .

Now, since s_2 has two distinct neighbours in L_1 , there exist two edges joining $s_2 \in X'_2$ and L_2 , a contradiction to Theorem 33(iii). This proves Lemma 60. \square

For $i \in \{1, 2\}$, we say that the brick J_i is *flexible* if none of the four edges in the set $\partial(V(L_i))$ depends on any of the other three edges; otherwise, we say that the brick J_i is *inflexible*. Analogous definitions apply to the brick J'_i — with L'_i playing the role of L_i .

Observe that, as per the above definitions: any member of \mathcal{J} , that is isomorphic to K_4 , is in fact inflexible. As a first step, we will prove that J_1 and J'_1 are both inflexible; to do so, we will need two lemmas.

Lemma 61. *If J_1 is flexible then $J'_1 \simeq K_4$. Likewise, if J'_1 is flexible then $J_1 \simeq K_4$.*

Proof. By symmetry, it suffices to prove the first statement. Assume that J_1 is flexible. Observe that $t_2 \in V(L'_1) \cap B'_2$. Our plan is to leverage the flexibility of J_1 to deduce that $V(L'_1) \cap (B_2 \cup B'_2) = \{t_2\}$, and then invoke Lemma 60.

Assertion 62. For each $p \in V(L'_1) - t_2$, the graph $G - e_2 - p - t_2$ is matchable; consequently, $p \notin B'_2$.

Proof of Assertion 62. We let M' denote a perfect matching of $J'_1 - p - t_2$. First suppose that $x_1x'_1 \in M'$. Consequently, $M' - x_1x'_1$ is a perfect matching of $L'_1 - p - t_2$. By Lemma 38, with e_3 playing the role of e' , the graph $G - e_2 - p - t_2$ is matchable.

Now suppose that $x_1x'_1 \notin M'$. Thus M' contains $h_1 = u_3t_3$, and it also contains exactly one of g'_1 and h'_1 . Adjust notation so that $h'_1 \in M'$. By Theorem 33(iii), at least one of d'_1 and f'_1 is not adjacent with h'_1 . Adjust notation so that d'_1 and h'_1 are nonadjacent. Now, we utilize the flexibility hypothesis, to choose a perfect matching M of J_1 that contains both edges d'_1 and $d_1 = u_2s_2$. Observe that M' and M satisfy the hypotheses of Lemma 39, and thus $M' \cup M \cup \{e_1\}$ may be extended to a perfect matching of $G - p - t_2$. Consequently, $G - e_2 - p - t_2$ is matchable. This proves Assertion 62. \square

Assertion 63. For each $p \in V(L'_1)$, the graph $G - e_2 - p - u_3$ is matchable; consequently, $p \notin B_2$.

Proof of Assertion 63. We let M' denote a perfect matching of $J'_1 - p - x_1$. Adjust notation so that $h'_1 \in M'$, and let z' denote the end of h'_1 in B'_1 . Adjust notation so that d'_1 and h'_1 are nonadjacent, and let y' denote the end of d'_1 in B'_1 . (Thus $y' \neq z'$.) As before, we make use of the flexibility hypothesis, to choose a perfect matching M of J_1 that contains both edges d'_1 and $d_1 = u_2s_2$. Now, we invoke Lemma 31 to choose a perfect matching N' of $G[X'_1 - u_1 - y' - z']$. Observe that $M \cup M' \cup N' \cup \{e_1\}$ is a perfect matching of $G - e_2 - p - u_3$. This proves Assertion 63. \square

It follows from Assertions 62 and 63 that $V(L'_1) \cap (B_2 \cup B'_2) = \{t_2\}$. Lemma 60 implies that $J'_1 \simeq K_4$. This completes the proof of Lemma 61. \square

Lemma 64. *Either each of J_1 and J'_1 is isomorphic to K_4 , or otherwise neither of them is isomorphic to K_4 .*

Proof. Assume that $J'_1 \simeq K_4$, whence $E(L'_1) = \{t_2t_3\}$. By Lemma 57, $J'_2 \simeq K_4$ and $V(L'_1) \cap V(L'_2) = \{t_3\}$.

If either of the sets B'_1 and B'_2 is a doubleton, we invoke Corollary 58 or Corollary 59 (as applicable) to deduce that G is the Petersen graph; in particular, $J_1 \simeq K_4$.

Now suppose that each of the sets B'_1 and B'_2 has three or more vertices. We will consider two cases depending on whether or not the set B_2 is a doubleton. (In each case, we will deduce that $J_1 \simeq K_4$.)

Case 1: The set B_2 is a doubleton.

Since $B_2 = \{u_1, u_3\}$, each of u_1 and u_3 has one neighbour in L_2 , and one neighbour in L'_2 . As per Notation 55, L_2 contains s_1 and s_3 , and L'_2 contains t_1 and t_3 . In particular, $E(L'_2) = \{t_1t_3\}$. Note that one of g'_1 and h'_1 is the edge t_1t_3 . Since $|B'_1| \geq 3$, the vertex t_1 has a neighbour in $I'_1 - u_1$, whence $d'_1, f'_1 \notin \partial(t_1)$.

Assertion 65. For each $p \in V(L_1) - s_2$, the graph $G - e_2 - p - s_2$ is matchable; consequently, $p \notin B'_2$.

Proof of Assertion 65. We let M denote a perfect matching of $J_1 - p - s_2$. First suppose that $x_1x'_1 \in M$, whence $M - x_1x'_1$ is a perfect matching of $L_1 - p - s_2$. By Lemma 38, with e_3 playing the role of e' , the graph $G - e_2 - p - s_2$ is matchable.

Now suppose that $x_1x'_1 \notin M$. Thus M contains $f_1 = u_3s_3$, and it also contains exactly one of d'_1 and f'_1 . Let $M' := \{u_2t_2, t_1t_3\}$. Since $d'_1, f'_1 \notin \partial(t_1)$, the matchings M and M' satisfy the hypotheses of Lemma 39, whence $M \cup M' \cup \{e_1\}$ may be extended to a perfect matching of $G - p - s_2$. Consequently, $G - e_2 - p - s_2$ is matchable. This proves Assertion 65. \square

It follows from Assertion 65 that $V(L_1) \cap B'_2 = \{s_2\}$. Clearly, $V(L_1) \cap B_2 = \emptyset$. Consequently, $V(L_1) \cap (B_2 \cup B'_2) = \{s_2\}$. By Lemma 60, $J_1 \simeq K_4$.

Case 2: The set B_2 has three or more vertices.

Since each of B_2 and B'_2 has cardinality at least three, by Lemma 31, each of the bipartite graphs $G[X_2 - v]$ and $G[X'_2 - u_2]$ is connected. We will investigate these two graphs, and use the fact that $\partial(V(L_1)) = \{d_1, f_1, d'_1, f'_1\}$ is a cut of G , to arrive at a contradiction.

Note that $d_1 = u_2s_2$ is neither an edge of $G[X_2 - v]$ nor of $G[X'_2 - u_2]$. Since $t_3 \in V(L'_2)$, and $|B_2| \geq 3$, the vertex s_3 lies in $I_2 - v$. Consequently, $f_1 = u_3s_3$ is an edge of $G[X_2 - v]$.

The connected graph $G[X'_2 - u_2]$ contains $s_2 \in V(L_1)$ and $t_2 \notin V(L_1)$; in other words, it meets each shore of the cut $\{d_1, f_1, d'_1, f'_1\}$; whence it contains at least one of these four edges. It follows from the preceding paragraph that at least one of d'_1 and f'_1 is an edge of $G[X'_2 - u_2]$. Adjust notation so that f'_1 is an edge of $G[X'_2 - u_2]$.

Now, we observe that $\{f_1\}$ is a 1-cut of $G[X_2 - v]$; furthermore, $G[X_2 - v] - f_1$ has precisely two components: the isolated vertex u_3 , and a nontrivial component, say Q . Note that $Q = G[X_2 - v] - u_3$. The connected graph Q contains $s_3 \in V(L_1)$ and $u_1 \notin V(L_1)$; whence Q contains at least one edge from $\{d_1, f_1, d'_1, f'_1\}$. We infer that $d'_1 \in E(Q)$.

Thus, the connected subgraph $G[X'_2 - u_2]$ contains exactly one edge from the cut $\{d_1, f_1, d'_1, f'_1\}$ — namely, f'_1 . Consequently, $\{f'_1\}$ is a 1-cut of $G[X'_2 - u_2]$; furthermore, one of its shores contains s_2 , and the other shore contains t_2 . By Lemma 31, each 1-cut of $G[X'_2 - u_2]$ is trivial. This implies that f'_1 is incident with one of s_2 and t_2 . Since $t_2 \in V(L'_1)$, it is not an end of f'_1 . Hence, $f'_1 \in \partial(s_2)$. Consequently, $\partial(V(L_1))$ is not a matching. By Theorem 33(vii), $L_1 \simeq K_2$, whence $J_1 \simeq K_4$. \square

The following is an immediate consequence of Lemmas 61 and 64.

Corollary 66. *Each of J_1 and J'_1 is inflexible.* \square

Since the brick J_1 is inflexible, by definition, some edge in $\partial(V(L_1)) = \{d_1, f_1, d'_1, f'_1\}$ depends on another edge in $\partial(V(L_1))$. Since any pair of such edges must be nonadjacent, we may adjust notation so that d_1 depends on d'_1 . By Theorem 33(vi), the edge $x_1x'_1$ participates in every nontrivial 3-cut of J_1 . Thus we may invoke Corollary 26 to infer that each of the sets $\{d_1, d'_1\}$ and $\{f_1, f'_1\}$ is a removable doubleton of J_1 . An analogous argument applies to J'_1 . These facts, and notational conventions, are summarized below. See Figure 8.

Notation 67. *Each of the sets $\{d_1, d'_1\}$ and $\{f_1, f'_1\}$ is a removable doubleton of J_1 , and likewise, each of the sets $\{g_1, g'_1\}$ and $\{h_1, h'_1\}$ is a removable doubleton of J'_1 .*

Proposition 68. *Each of the bricks J_1 and J'_1 is isomorphic to K_4 . In particular, $E(L_1) = \{s_2s_3\}$ and $E(L'_1) = \{t_2t_3\}$.*

Proof. By Lemma 64, it suffices to show that one of J_1 and J'_1 is isomorphic to K_4 . Suppose, to the contrary, that neither J_1 nor J'_1 is isomorphic to K_4 . Consequently, each of L_1 and L'_1 has four or more vertices; by Theorem 33(vii), each of them is 2-connected; furthermore, each of the sets $\partial(V(L_1))$ and $\partial(V(L'_1))$ is a matching in G .

We let S and S' denote the color classes of $J_1 - d_1 - d'_1$ so that d_1 has both ends in S . Consequently, $x_1, s_2 \in S$, and $x'_1, s_3 \in S'$. Likewise, we let T and T' denote the color classes of $J'_1 - g_1 - g'_1$ so that g_1 has both ends in T . Consequently, $x_1, t_2 \in T$, and $x'_1, t_3 \in T'$. See Figure 8.

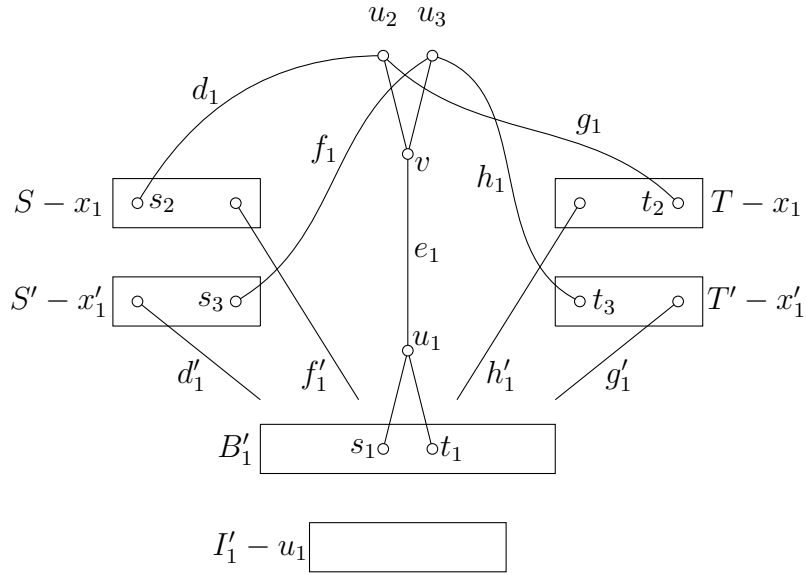

Figure 8: The bricks J_1 and J'_1 are both inflexible

Assertion 69. The edges d'_1 and g'_1 are nonadjacent.

Proof of Assertion 69. We first claim that s_3 has a neighbour, distinct from u_3 , that does not lie in B'_2 . Suppose, to the contrary, that each neighbour of s_3 , distinct from u_3 , belongs to B'_2 . Consequently, s_3 has two neighbours in B'_2 , and it has one neighbour (namely u_3) in B_2 . Thus, $s_3 \in V(L_2) \cup V(L'_2)$, and as per Notation 55, $s_3 \in V(L_2)$. Furthermore, there are two adjacent edges joining L_2 and X'_2 , contrary to Theorem 33(iii). Thus s_3 has a neighbour, say w , such that $w \neq u_3$ and $w \notin B'_2$.

By Theorem 33(iii), B'_2 is a maximal barrier of $G - e_2$. Since $s_2 \in B'_2$ and $w \notin B'_2$, by Theorem 1, these two vertices do not lie in a common barrier of $G - e_2$. Thus, $G - e_2 - w - s_2$ has a perfect matching, say N . Note that, the graph L_1 is bipartite and has equicardinal color classes, namely $S - x_1$ and $S' - x'_1$. Also, w and s_2 both lie in $S - x_1$. Since $S - x_1$ is a stable set, we infer that d'_1 and $f_1 = u_3 s_3$ belong to N .

Observe that $g_1 = u_2 t_2$ belongs to N . Since, $f_1 \in N$, the edge $h_1 = u_3 t_3$ does not lie in N . Since L'_1 is also bipartite and has equicardinal color classes, namely $T - x_1$ and $T' - x'_1$, we infer that $g'_1 \in N$.

In particular, we have shown that $d'_1, g'_1 \in N$. Thus they are nonadjacent. \square

We let y' and z' , in the set B'_1 , denote the ends of d'_1 and g'_1 , respectively. By Assertion 69, y' and z' are distinct.

Assertion 70. For each $p \in V(L_1) - s_2$, the graph $G - e_2 - p - s_2$ is matchable; consequently, $p \notin B'_2$.

Proof of Assertion 70. As noted earlier, L_1 is a bipartite graph with color classes $S - x_1$ and $S' - x'_1$. We let $p \in V(L_1) - s_2$.

First suppose that $p \in S'$. By Lemma 40, the edge $x_1x'_1$ is admissible in the graph $J_1 - d_1 - d'_1 - p - s_2$. Consequently, $L_1 - p - s_2$ is matchable. By Lemma 38, with the edge e_3 playing the role of e' , the graph $G - e_2 - p - s_2$ is matchable, and we are done.

Now suppose that $p \in S$. Let M denote a perfect matching of $J_1 - p - s_2$. Since p and s_2 both belong to the color class S of the bipartite graph $J_1 - d_1 - d'_1$, the edge d'_1 lies in M . Now, let M' denote a perfect matching of J'_1 that contains the edge $g_1 = u_2t_2$. Since $\{g_1, g'_1\}$ is a removable doubleton of J'_1 , the edge g'_1 lies in M' .

Since $y' \neq z'$, the matchings M and M' satisfy the hypotheses of Lemma 39, with s_2 playing the role of q . Consequently, with e_1 playing the role of e , we may extend $M \cup M' \cup \{e_1\}$ to a perfect matching of $G - p - s_2$. Thus, $G - e_2 - p - s_2$ is matchable, and we are done. \square

Assertion 71. For each $p \in V(L_1)$, the graph $G - e_2 - p - u_3$ is matchable; consequently, $p \notin B_2$.

Proof of Assertion 71. We let $p \in V(L_1)$. First suppose that $p \in S$. Let M denote a perfect matching of $J_1 - p - x_1$. Since $p, x_1 \in S$, the edge $d'_1 \in M$. Let M' denote a perfect matching of J'_1 that contains g_1 , whence $g'_1 \in M'$. Invoking Lemma 31, we choose a perfect matching N' of $G[X'_1 - u_1 - y' - z']$. Observe that $M \cup M' \cup N' \cup \{e_1\}$ is a perfect matching of $G - e_2 - p - u_3$.

Now suppose that $p \in S'$. We let M denote a perfect matching of $J_1 - p - x'_1$. Since $p, x'_1 \in S'$, the edge $d_1 \in M$. We let $w' \in B'_1$ and $t' \in T$ denote the ends of h'_1 . Since J'_1 is bicritical, we may choose a perfect matching M' of $J'_1 - t' - x_1$. Clearly, $g'_1 \in M'$. Since $\partial(V(L_1))$ is a matching in G , the vertices w' and z' are distinct. Invoking Lemma 31, we choose a perfect matching N' of $G[X'_1 - u_1 - w' - z']$. Observe that $M \cup M' \cup N' \cup \{h'_1, e_1\}$ is a perfect matching of $G - e_2 - p - u_3$. \square

It follows from Assertions 70 and 71 that $V(L_1) \cap (B_2 \cup B'_2) = \{s_2\}$. By Lemma 60, $J_1 \simeq K_4$, contrary to our assumption. This completes the proof of Proposition 68. \square

So far we have proved that the barrier B_1 of $G - e_1$ is a doubleton, and that both bricks of $G - e_1$ are isomorphic to K_4 . Now we deduce, using Lemma 57, that analogous facts also hold for the graph $G - e_2$.

Corollary 72. *The set B_2 is a doubleton, and each of the bricks J_2 and J'_2 is isomorphic to K_4 . In particular, $E(L_2) = \{s_1s_3\}$ and $E(L'_2) = \{t_1t_3\}$.*

Proof. Since each of J_1 and J'_1 is isomorphic to K_4 , by Lemma 57, each of J_2 and J'_2 is also isomorphic to K_4 ; furthermore, $s_3 \in V(L_2)$ and $t_3 \in V(L'_2)$. Consequently, u_3 has no neighbours in $I_2 - v$, whence Lemma 31 implies that B_2 is a doubleton. In particular, $B_2 = \{u_1, u_3\}$. It follows that u_1 has a neighbour in each of L_2 and L'_2 . As per Notation 55, $s_1 \in V(L_2)$ and $t_1 \in V(L'_2)$. Hence, $E(L_2) = \{s_1s_3\}$ and $E(L'_2) = \{t_1t_3\}$. This completes the proof of Corollary 72. \square

In summary, each of B_1 and B_2 is a doubleton, and each member of \mathcal{J} is isomorphic to K_4 . We adjust notation so that $d_2, g_2 \in \partial(u_1)$ and $f_2, h_2 \in \partial(u_3)$, and we adopt the conventions stated below. See Figure 9.

Notation 73. Each of the sets $\{d_2, d'_2\}$ and $\{f_2, f'_2\}$ is a removable doubleton of J_2 , and likewise, each of the sets $\{g_2, g'_2\}$ and $\{h_2, h'_2\}$ is a removable doubleton of J'_2 .

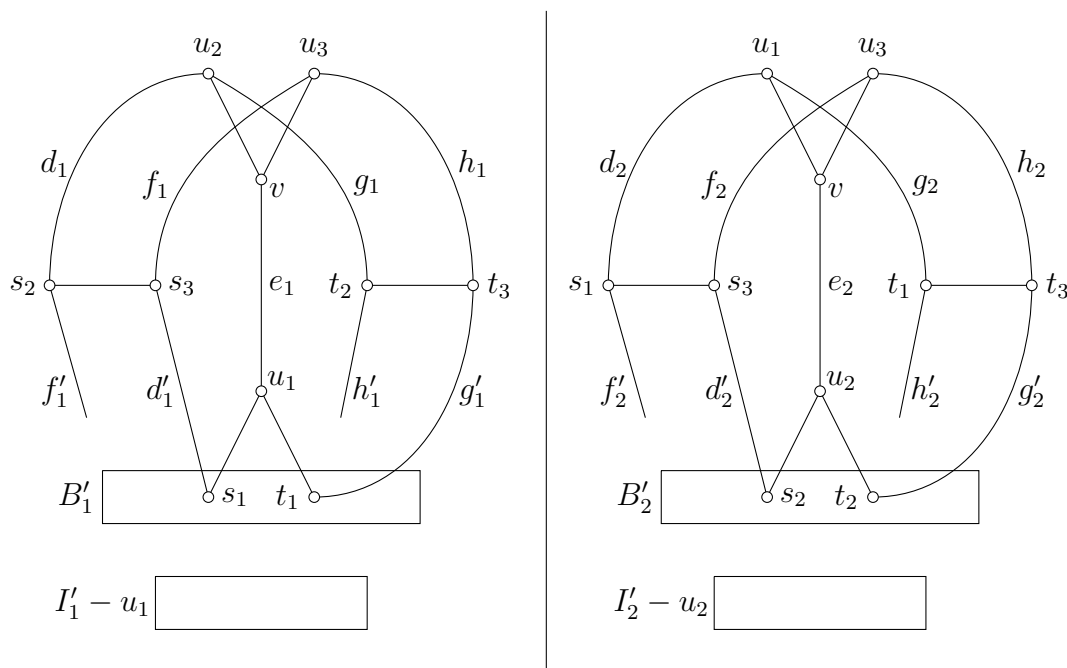

Figure 9: Each of the sets B_1 and B_2 is a doubleton, and each brick in \mathcal{J} is isomorphic to K_4

For a vertex w , we use $N(w)$ to denote its neighbourhood. For instance, $N(u_3) = \{v, s_3, t_3\}$. We let H^* denote the subgraph $G - u_3 - N(u_3)$. The following is easy to see.

Proposition 74. The graph H^* is connected and bipartite, with color classes $B'_1 \cup \{u_2\} = I'_2 \cup \{s_1, t_1\}$ and $B'_2 \cup \{u_1\} = I'_1 \cup \{s_2, t_2\}$. \square

Figure 10 shows a different drawing of the graph G that displays the subgraph H^* clearly. The reader may easily verify the following.

Proposition 75. Let Q denote any nonbipartite subgraph of G . Then $V(Q) \cap N(u_3)$ is nonempty. Furthermore, the following hold:

- (i) If $V(Q) \cap N(u_3) = \{s_3\}$ then $s_1, s_2 \in V(Q)$.
- (ii) If $V(Q) \cap N(u_3) = \{t_3\}$ then $t_1, t_2 \in V(Q)$.
- (iii) if $V(Q) \cap N(u_3) = \{v\}$ then $u_1, u_2 \in V(Q)$. \square

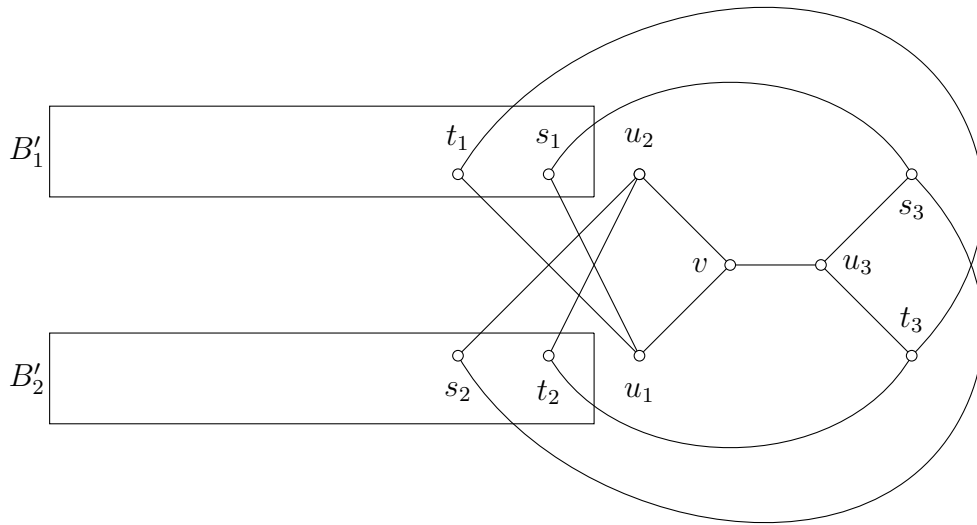

Figure 10: The graph G and its connected bipartite subgraph $H^*[B'_1 \cup \{u_2\}, B'_2 \cup \{u_1\}]$

5.3 Nonsolid, nonplanar and non-Pfaffian

Since G has quasi- b -invariant edges, it follows from Theorem 18 that G is nonsolid. Figure 11(a) shows a subgraph that is a subdivision of $K_{3,3}$. This subgraph also clearly depicts 4 pentagons; we will find this useful in the proof of Proposition 80.

Proposition 76. *The graph G is nonplanar.* □

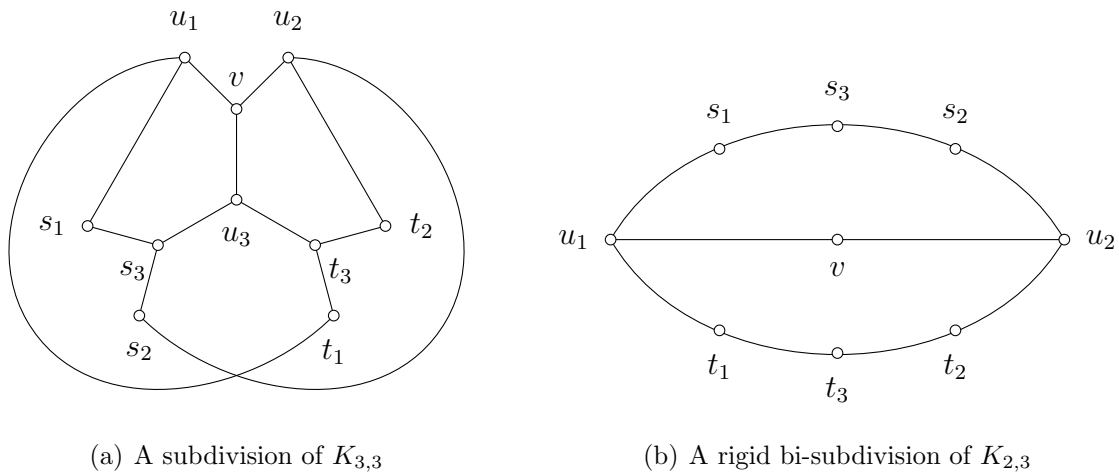

Figure 11: The brick G is nonplanar and non-Pfaffian

Note that, since G is triangle-free, s_1 and s_2 are nonadjacent; likewise, t_1 and t_2 are nonadjacent. The following is easy to see.

Lemma 77. *The following are equivalent:*

- (i) *At least one of f'_1 and h'_1 belongs to $\partial(s_1) \cup \partial(t_1)$.*
- (ii) *At least one of f'_2 and h'_2 belongs to $\partial(s_2) \cup \partial(t_2)$.*
- (iii) *G is the Petersen graph.* □

Proposition 78. ² *The graph G is non-Pfaffian.*

Proof. The Petersen graph is non-Pfaffian. Now suppose that G is not the Petersen graph. Let y_2 denote the end of f'_1 in B'_1 , and let z_2 denote the end of h'_1 in B'_1 . See Figure 9. Note that y_2 and z_2 need not be distinct. However, by Lemma 77, $\{y_2, z_2\} \cap \{s_1, t_1\} = \emptyset$.

Figure 11(b) shows a subgraph of G that is a bi-subdivision of $K_{2,3}$. By Lemma 43, it suffices to show that this subgraph is a rigid bi-subdivision of $K_{2,3}$.

We let $P_1 := u_1s_1s_3s_2u_2$, $P_2 := u_1vu_2$ and $P_3 := u_1t_1t_3t_2u_2$ denote the three edge-disjoint u_1u_2 -paths. For $i, j \in \{1, 2, 3\}$, where $i < j$, we let $C_{i,j}$ denote the cycle $P_i \cup P_j$. Thus, we only need to argue that each of the cycles $C_{1,2}, C_{2,3}$ and $C_{1,3}$ is conformal in G . (The reader may find it useful to trace each of these cycles in Figure 9.)

Let us begin with the octagon $C_{1,3}$. By Lemma 31, $G[X'_1 - u_1 - s_1 - t_1]$ has a perfect matching, say M . Observe that $M \cup \{e_3\}$ is a perfect matching of $G - V(C_{1,3})$. Thus $C_{1,3}$ is conformal.

Now let us consider the hexagon $C_{1,2}$. Since s_1 and z_2 are distinct, by Lemma 31, $G[X'_1 - u_1 - s_1 - z_2]$ has a perfect matching, say M' . Observe that $M' \cup \{h_1, h'_1\}$ is a perfect matching of $G - V(C_{1,2})$. Thus $C_{1,2}$ is conformal. An analogous argument shows that $C_{2,3}$ is conformal.

As discussed earlier, this completes the proof of Proposition 78. □

Thus far we have proved statements (i) and (ii) of Theorem 19. It remains to prove statements (iii) and (iv).

5.4 The Cubplex

In this section, our goal is to prove statement (iii) of Theorem 19.

Lemma 79. *The following are equivalent:*

- (i) *The edges f'_1 and h'_1 are adjacent.*
- (ii) *The edges f'_2 and h'_2 are adjacent.*
- (iii) *G is the Cubplex.*

²By Kasteleyn's Theorem, every non-Pfaffian graph is nonplanar. However, we have presented separate certificates for nonplanarity and non-Pfaffian-ness, since they are easy to observe.

Proof. We first prove that (i) implies (ii) and (iii). Suppose that $y_1 \in B'_1 - s_1 - t_1$ is a common end of f'_1 and h'_1 . We observe that $\partial(\{v, u_1, u_2, u_3, s_1, t_1, s_2, t_2, s_3, t_3, y_1\})$ is a 3-cut of G , and since G is essentially 4-edge-connected, all three edges are incident at one vertex, say y_2 . In particular, $y_2s_1, y_2t_1, y_2y_1 \in E(G)$, and G is indeed the Cubeplex. Also, by symmetry, (ii) implies (i) and (iii).

Now we prove that (iii) implies (i) and (ii). Suppose that G is the Cubeplex, whence G has exactly 12 vertices. Consequently, $|B'_1| = 3$. Let y_1 denote the unique vertex of $B'_1 - s_1 - t_1$, and let y_2 denote the unique vertex of $I'_1 - u_1$. Clearly, y_2 is incident with each vertex of B'_1 , and $f'_1, h'_1 \in \partial(y_1)$. This completes the proof of Lemma 79. \square

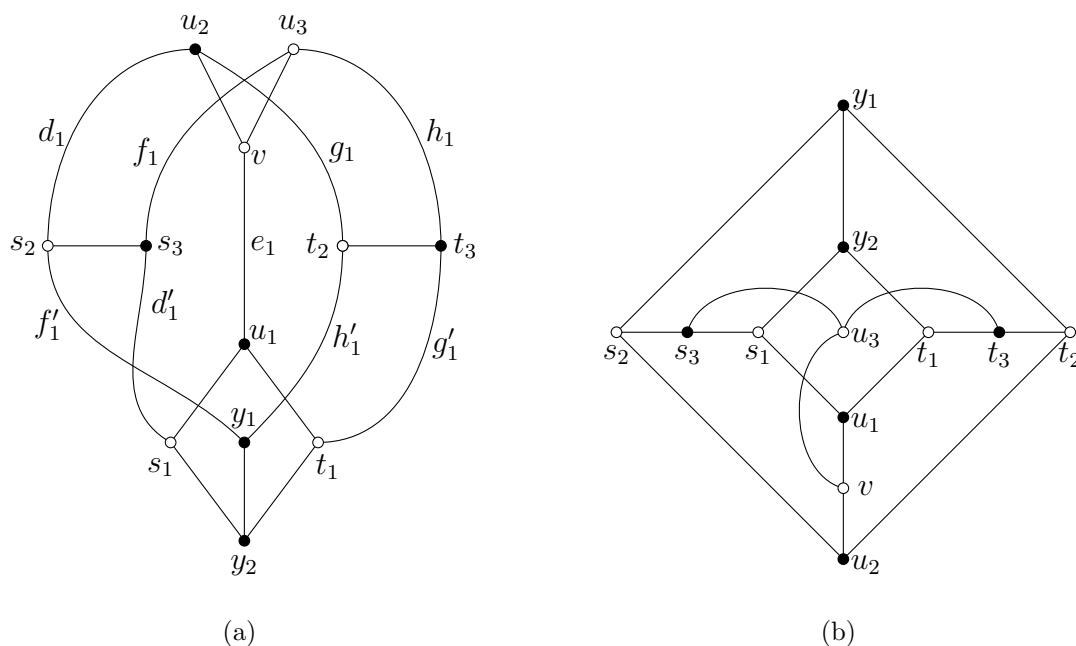

Figure 12: Two drawings of the Cubeplex

Proposition 80. *If G is near-bipartite then G is the Cubeplex; furthermore, e_3 participates in the (unique) removable doubleton of G .*

Proof. Assume that G is near-bipartite, and let R denote a removable doubleton of G . In particular, $G - R$ is a bipartite graph, and R comprises two nonadjacent edges.

We observe the four 5-cycles of G that are clearly depicted in Figure 11(a); view each of them as an edge set. Let $C_1 := (vu_3, u_3s_3, s_1s_1, s_1u_1, u_1v)$, $C_2 := (vu_3, u_3s_3, s_3s_2, s_2u_2, u_2v)$, $C_3 := (vu_3, u_3t_3, t_3t_1, t_1u_1, u_1v)$, $C_4 := (vu_3, u_3t_3, t_3t_2, t_2u_2, u_2v)$, and $\mathcal{C} := \{C_1, C_2, C_3, C_4\}$. Since $G - R$ is bipartite, the doubleton R meets each member of \mathcal{C} .

We claim that $e_3 := vu_3$ lies in R . Suppose not. Observe that any three distinct members of \mathcal{C} have exactly one edge in common — namely, e_3 . Since $e_3 \notin R$, one edge of R meets precisely two members of \mathcal{C} , and the other edge of R meets the remaining two

members of \mathcal{C} . We note that $C_1 \cap C_2 = \{e_3, u_3s_3\}$, $C_1 \cap C_3 = \{e_3, vu_1\}$, $C_1 \cap C_4 = \{e_3\}$, $C_2 \cap C_3 = \{e_3\}$, $C_2 \cap C_4 = \{e_3, vu_2\}$, and $C_3 \cap C_4 = \{e_3, u_3t_3\}$. These observations imply that either $R = \{u_3s_3, u_3t_3\}$ or $R = \{vu_1, vu_2\}$. This is absurd — since the two edges of R are nonadjacent.

We have shown that $e_3 \in R$, whence G has a unique removable doubleton. Let f_3 denote the edge of R that is distinct from e_3 , and let A and B denote the color classes of the bipartite graph $G - R$ such that e_3 has both ends in A . We let $y_1, y_2 \in B$ denote the ends of f_3 .

Since $e_3 = vu_3$, the neighbourhood of $\{v, u_3\}$ is a subset of B . Thus $u_1, u_2, s_3, t_3 \in B$. Now, we observe that each vertex in $\{s_1, t_1, s_2, t_2\}$ has two neighbours in $\{u_1, u_2, s_3, t_3\}$; consequently, $s_1, t_1, s_2, t_2 \in A$. Note that each vertex in $\{u_1, u_2, s_3, t_3\}$ has three neighbours in A ; whence each of them is distinct from y_1 , and from y_2 . We have thus located six distinct vertices in A , and likewise, six in B . Note that f_3 has one end in $B'_1 - \{s_1, t_1\}$ and another end in $I'_1 - u_1$.

We adjust notation so that $y_1 \in B'_1$ and $y_2 \in I'_1 - u_1$. Since $|B'_1| \geq 3$, by Lemma 31, the bipartite graph $G[X'_1 - u_1]$ is connected; this graph contains f_3 but it does not contain e_3 . We claim that $G[X'_1 - u_1] - f_3$ is disconnected. Suppose not. Then its color classes are B'_1 and $I'_1 - u_1$. However, since $G[X'_1 - u_1] - f_3$ is a subgraph of the connected bipartite graph $G - R$, one of its color classes is a subset of A , and the other is a subset of B . However, since $y_1, y_2 \in B$, we have a contradiction.

Thus $\{f_3\}$ is a 1-cut of $G[X'_1 - u_1]$; by Lemma 31, it must be a trivial cut. Hence, y_1 is an isolated vertex of $G[X'_1 - u_1] - f_3$. We infer that $f'_1, h'_1 \in \partial(y_1)$. By Lemma 79, G is indeed the Cubeplex. This proves Proposition 80. \square

5.5 The Petersen graph

In this section, our goal is to prove statement (iv) of Theorem 19.

Lemma 81. *If $e_3 = vu_3$ is quasi- b -invariant then G is the Petersen graph.*

Proof. We assume that e_3 is quasi- b -invariant and, as usual, we adopt the notation and conventions introduced in Theorem 33 and Notation 37 — with the only difference being that all of the notation (except for the vertex v) is decorated with subscript 3.

All of the preceding arguments, pertaining to the pair of adjacent quasi- b -invariant edges e_1 and e_2 , are also applicable to the pair e_1 and e_3 . Consequently, $B_3 = \{u_1, u_2\}$, and each of the bricks J_3 and J'_3 is isomorphic to K_4 , whence each of L_3 and L'_3 is isomorphic to K_2 . Furthermore, for $j \in \{1, 2\}$, each of the sets $V(L_3) \cap \{s_j, t_j\}$ and $V(L'_3) \cap \{s_j, t_j\}$ is a singleton. Adjust notation so that $s_1 \in V(L_3)$. Since G is triangle-free, $t_2 \in V(L_3)$ and $s_1t_2 \in E(G)$. By Lemma 77, G is indeed the Petersen graph. This proves Lemma 81. \square

Proposition 82. *If G has a quasi- b -invariant edge, distinct from e_1 and e_2 , then G is the Petersen graph.*

Proof. Assume that $e^* := v^*u^*$ is a quasi- b -invariant edge of G , distinct from e_1 and e_2 . If $e^* = e_3$ then the desired conclusion holds by Lemma 81

Now suppose that $e^* \neq e_3$, whence $v \notin \{v^*, u^*\}$. We adopt the notation and conventions introduced in Theorem 33 — as shown in Figure 13.

We first consider the case in which $e^* \in \{u_3s_3, u_3t_3\}$. Adjust notation so that $u_3 = v^*$ and $s_3 = u^*$, whence $v, t_3 \in B$ and $s_1, s_2 \in B'$. Since u_1 is a common neighbour of $v \in B$ and $s_1 \in B'$, we infer that $u_1 \in V(L) \cup V(L')$. Adjust notation so that $u_1 \in V(L)$. Since $\partial(V(L))$ is not a matching, $L \simeq K_2$ and $E(L) = \{u_1t_1\}$. A similar argument shows that $L' \simeq K_2$ and $E(L') = \{u_2t_2\}$. Consequently, v has no neighbours in $I - v^*$, whence B is a doubleton. Observe that $G[X' - u^*]$ is a subgraph of the connected bipartite graph $G - u_3 - N(u_3)$. If $|B'| \geq 3$ then, by Lemma 31, $G[X' - u^*]$ is a connected subgraph with color classes B' and $I' - u^*$; however, this results in a contradiction since s_1 and s_2 lie in distinct color classes of $G - u_3 - N(u_3)$. Thus B' is a doubleton, whence $|V(G)| = 10$. By Proposition 41, G is indeed the Petersen graph.

Now suppose that $e^* \notin \{u_3s_3, u_3t_3\}$. Thus, $u_3 \notin \{v^*, u^*\}$.

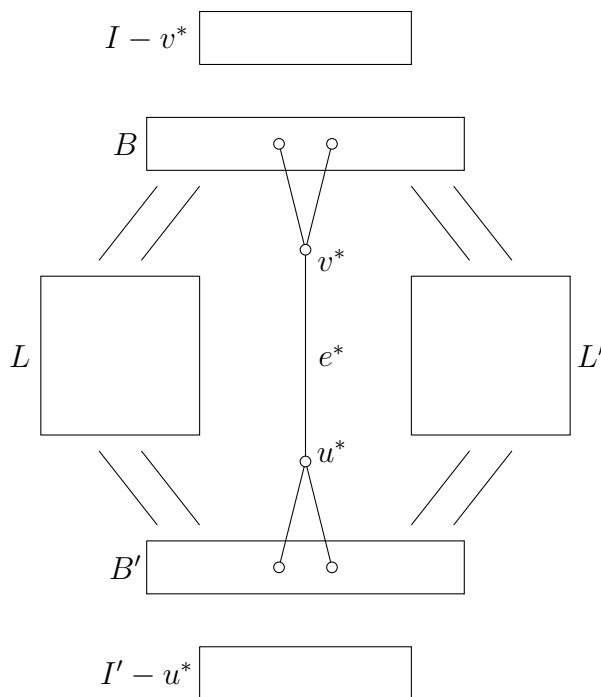

Figure 13: Illustration for the proof of Proposition 82

We define four subgraphs as follows. We let $G_1 := G[V(L) \cup X]$, $G_2 := G[V(L') \cup X']$, $G_3 := G[V(L') \cup X]$, and $G_4 := G[V(L) \cup X']$. By Theorem 33(v), each of these four subgraphs is nonbipartite. Consequently, Proposition 75 applies to all of them. In particular, each of these four subgraphs meets the set $N(u_3) = \{v, s_3, t_3\}$; in the arguments that follow, we will use this fact implicitly.

Assertion 83. The set $N(u_3)$ meets $X \cup X'$.

Proof of Assertion 83. Suppose, to the contrary, that $N(u_3) \cap (X \cup X')$ is empty. Thus $v, s_3, t_3 \in V(L) \cup V(L')$; adjust notation so that two of them lie in $V(L)$, and the third one lies in $V(L')$. Since u_3 is a common neighbour, $u_3 \in X \cup X'$; adjust notation so that $u_3 \in X$. Thus there exist two adjacent edges joining X and L . This contradicts Theorem 33(iii). \square

Assertion 84. The set $N(u_3)$ meets $V(L) \cup V(L')$.

Proof of Assertion 84. Suppose, to the contrary, that $N(u_3) \cap (V(L) \cup V(L'))$ is empty. Thus $v, s_3, t_3 \in X \cup X'$; adjust notation so that two of them lie in X , and the third one lies in X' . Since u_3 is a common neighbour, we infer that, in fact, two of them lie in B , the third one lies in B' and $u_3 \in V(L) \cup V(L')$, contrary to Theorem 33(iii). \square

We may adjust notation so that one vertex of $N(u_3)$ lies in X , another vertex of $N(u_3)$ lies in $V(L)$, and the third vertex lies in $X' \cup V(L')$. We consider two cases depending on whether the third vertex lies in X' or in $V(L')$.

Case 1: $N(u_3) \cap V(L')$ is nonempty.

We consider two cases depending on whether or not v lies in X .

Case 1.1: $v \in X$.

Adjust notation so that $s_3 \in V(L)$ and $t_3 \in V(L')$. By our assumption $v \neq v^*$, whence the common neighbour $u_3 \in B$, and $v \in I - v^*$. Consequently, $u_1, u_2 \in B$. Since G_4 is nonbipartite, Proposition 75 implies that $s_1, s_2 \in V(L)$. This is absurd — since it results in three distinct edges joining L and X .

Case 1.2: $v \notin X$.

Adjust notation so that $t_3 \in X, s_3 \in V(L)$ and $v \in V(L')$. The common neighbour $u_3 \in B$, and $t_3 \in I$. First suppose that $t_3 \in I - v^*$, whence $t_1, t_2 \in B$. Since G_2 is nonbipartite, Proposition 75 implies that $u_1, u_2 \in V(L')$. This is absurd — since it results in three distinct edges joining L' and X .

Now suppose that $t_3 = v^*$, whence B is a doubleton. Adjust notation so that $t_2 \in B$ and $t_1 = u^*$. Consequently, $u_1 \in B'$. Observe that $\partial(V(L'))$ is not a matching, whence $L' \simeq K_2$ and $E(L') = \{vu_2\}$. Now it follows that $s_2 \in B'$. Consequently, $\partial(V(L))$ is not a matching; thus $L \simeq K_2$ and $E(L) = \{s_3s_1\}$. This implies that $t_2s_1 \in E(G)$. By Lemma 77, G is indeed the Petersen graph.

Case 2: $N(u_3) \cap X'$ is nonempty.

We consider two cases depending on whether or not v lies in $V(L)$.

Case 2.1: $v \in V(L)$.

Adjust notation so that $s_3 \in X$ and $t_3 \in X'$. We infer that the common neighbour $u_3 \in V(L)$, and that $s_3 \in B$ and $t_3 \in B'$. Since $\partial(V(L))$ is not a matching, $L \simeq K_2$ and $E(L) = \{vu_3\}$. Consequently, one of u_1 and u_2 lies in B , and the other lies in B' . Adjust

notation so that $u_1 \in B$ and $u_2 \in B'$. Since s_2 is a common neighbour of $s_3 \in B$ and $u_2 \in B'$, we infer that $s_2 \in V(L')$. Likewise, t_1 is a common neighbour of $u_1 \in B$ and $t_3 \in B'$, whence $t_1 \in V(L')$. Also, $\partial(V(L'))$ is not a matching; consequently, $L' \simeq K_2$ and $s_2t_1 \in E(G)$. By Lemma 77, G is indeed the Petersen graph.

Case 2.2: $v \notin V(L)$.

Adjust notation so that $t_3 \in V(L)$, $s_3 \in X$ and $v \in X'$. Thus their common neighbour $u_3 \in V(L)$, and $s_3 \in B$ and $v \in B'$. Since $\partial(V(L))$ is not a matching, $L \simeq K_2$ and $E(L) = \{t_3u_3\}$. One of t_1 and t_2 lies in B , and the other lies in B' . Adjust notation so that $t_1 \in B$ and $t_2 \in B'$. Since u_1 is a common neighbour of $t_1 \in B$ and $v \in B'$, we infer that $u_1 \in V(L')$. Since $\partial(V(L'))$ is not a matching, $L' \simeq K_2$ and $E(L') = \{u_1s_1\}$. We observe that $vu_2s_2s_3$ is a path that joins $v \in B'$ and $s_3 \in B$; this implies that $u_2 = u^*$ and $v^* = s_2$. Now $v \in B'$ has no neighbours in $I' - u^*$, whence B' is a doubleton, and $t_2s_1 \in E(G)$. By Lemma 77, G is indeed the Petersen graph.

Thus, in each case, we have either arrived at a contradiction, or we have arrived at the conclusion that G is the Petersen graph. This completes the proof of Proposition 82. \square

This completes the proof of the Main Theorem (19). \square

6 Consequences of the Main Theorem

We let \mathcal{G} denote the set of all essentially 4-edge-connected cubic bricks, except for K_4 . We partition \mathcal{G} into two subsets \mathcal{G}_1 and \mathcal{G}_2 as follows. A graph $G \in \mathcal{G}$ belongs to \mathcal{G}_2 if and only if G has a vertex that is incident with at least two quasi- b -invariant edges. In particular, the Petersen graph and the Cubplex are members of \mathcal{G}_2 . The Cubplex is the only near-bipartite member of \mathcal{G}_2 , and it has precisely two quasi- b -invariant edges and a unique removable doubleton; whence it has 14 b -invariant edges. Now, we prove Theorem 14 which states that, if G is any non-near-bipartite member of \mathcal{G} , distinct from the Petersen graph, then at least two-third of its edges are b -invariant.

Proof of Theorem 14. First suppose that G is a non-near-bipartite member of \mathcal{G}_2 distinct from the Petersen graph. By Theorem 19, G has precisely two quasi- b -invariant edges and $\frac{3|V(G)|}{2} - 2$ b -invariant edges.

Now suppose that G is a non-near-bipartite member of \mathcal{G}_1 , whence each vertex of G is incident with at least two b -invariant edges; consequently, G has at least $|V(G)|$ b -invariant edges. This completes the proof of Theorem 14. \square

We now point out some other interesting facts that are immediate consequences of Theorem 19. Let G be any member of \mathcal{G}_2 that is distinct from the Petersen graph. Then G has a unique vertex that v that is incident with precisely two quasi- b -invariant edges e_1 and e_2 . Let $e_3 := vu_3$ denote the third edge incident with v . It follows that the automorphism group of G has at least two singleton orbits: $\{v\}$ and $\{u_3\}$. In particular, the Petersen graph is the only vertex-transitive member of \mathcal{G}_2 .

As mentioned earlier, the Cubeplex and the Twinplex are the only two near-bipartite graphs that are minimally non-Pfaffian (see [10, 8]). It has always intrigued us that the Twinplex is far more symmetric than the Cubeplex; in particular, the automorphism group of the Twinplex has no singleton orbits. The discussion in the preceding paragraph perhaps throws some more light on this phenomenon.

As per Theorem 19, each member of \mathcal{G}_2 is nonsolid, nonplanar and non-Pfaffian. By Theorem 53, each member of \mathcal{G}_2 , except the Petersen graph, is $\overline{C_6}$ -based.

Now let $G \in \mathcal{G}_2$ and let e denote a quasi- b -invariant edge. Then both bricks of $G - e$ are isomorphic to K_4 . By Theorem 49, $G - e$ is K_4 -based. Consequently, G is also K_4 -based.

The following is a brief summary of the above discussion pertaining to the bricks in \mathcal{G}_2 .

Corollary 85. *Let G denote any member of \mathcal{G}_2 that is distinct from the Petersen graph. Then the following statements hold:*

- (i) G has exactly two quasi- b -invariant edges, say e_1 and e_2 , and these are adjacent.
- (ii) If G is not the Cubeplex then each edge, except e_1 and e_2 , is b -invariant; in particular, G is non-near-bipartite.
- (iii) The automorphism group of G has at least two singleton orbits.
- (iv) G is nonplanar and non-Pfaffian.
- (v) G is $\overline{C_6}$ -based and nonsolid.
- (vi) G is K_4 -based. □

7 An infinite family of cubic bricks

Let us recall Theorem 17, which states that, if e is a removable edge of an essentially 4-edge-connected cubic brick, then $b(G - e) \in \{1, 2\}$.

In this section, we will demonstrate that the conclusion of Theorem 17 does not hold for cubic bricks, in general. In particular, for any integer $k \geq 3$, we describe how one may construct a cubic brick G that has a removable edge e so that $b(G - e) = k$.

We will start from a cubic brace H of order $2k + 2$, and we will perform a few operations in order to obtain G . In particular, we will require the operation of ‘splicing’ two graphs, that is defined formally in [20]. The following is easy to prove.

Proposition 86. *A splicing of any two matching covered graphs yields another matching covered graph. A splicing of any two bicritical graphs yields another bicritical graph. □*

Some well-known examples of infinite families of cubic braces are: the prisms of order $4k$ where $k \geq 2$, and the Möbius ladders of order $4k + 2$ where $k \geq 1$. See [12] for definitions. The smallest prism is the cube graph, shown in Figure 14(a), and we shall use this to illustrate the construction that we are about to describe.

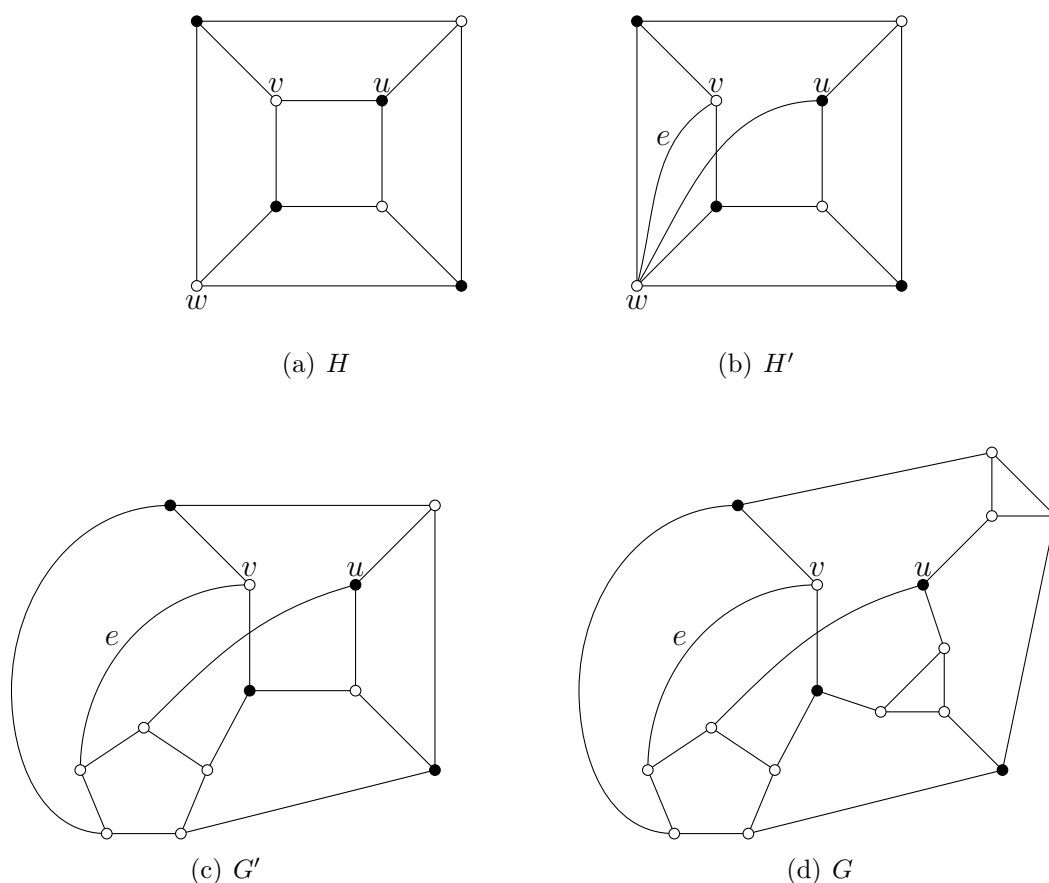

Figure 14: Constructing a cubic brick G with a removable edge e so that $b(G - e) = 3$

Let $k \geq 3$ be an integer. We consider any cubic brace $H[A, B]$ of order $2k + 2$. We choose an edge uv , adjusting notation so that $v \in A$ and $u \in B$, and we choose a vertex $w \in A$ such that u and w are nonadjacent. (Such a choice is possible since H is of order eight or more.) Now, let $H' := H - uv + uw + vw$. Observe that H' is a simple graph, in which vertex w has degree five, and every other vertex is cubic. Also, H' is not matching covered; in particular, the edge $e := vw$ is inadmissible. See Figures 14(a) and 14(b).

We let G' denote a cubic graph obtained by splicing H' , and the odd wheel W_5 , at their only noncubic vertices. (This is equivalent to ‘replacing’ the vertex w , of H' , by a 5-cycle, so as to obtain a cubic graph.) See Figures 14(b) and 14(c).

We let G denote the cubic graph obtained by splicing G' with a copy of K_4 at each vertex in the set $A - v - w$. (Splicing a cubic graph with K_4 , at a given vertex, is equivalent to ‘replacing’ that vertex by a triangle so as to obtain another cubic graph.) See Figures 14(c) and 14(d).

In the proof of the following, we will omit a few details. However, we provide all of the important steps.

Proposition 87. *The graph G is a cubic brick, and e is a removable edge of G . Furthermore, $b(G - e) = k$.*

Proof. First of all, we argue why G is a brick. As noted in Section 1.1, every cubic brace is essentially 4-edge-connected. In particular, H is essentially 4-edge-connected. Using this fact, one may deduce that H' is free of nontrivial 3-cuts. Now, since G' is obtained by splicing H' and the odd wheel W_5 , one may infer that G' is also free of nontrivial 3-cuts. Thus, G' is an essentially 4-edge-connected cubic graph. Since G' is nonbipartite, Corollary 9 implies that G' is a brick. In particular, by Theorem 5, G' is a bicritical graph.

Since G is obtained from the bicritical graph G' by repeatedly splicing with copies of the bicritical graph K_4 , it follows from Proposition 86 that G is also bicritical. Clearly, G is cubic. Thus, by Corollary 22, G is a brick.

Now we argue why e is a removable edge of G , or equivalently, why $G - e$ is matching covered. In a brace (of order six or more), every edge is removable. Thus $H - uv$ is a bipartite matching covered graph. Proposition 35 implies that any bipartite graph, which is obtained from a bipartite matching covered graph by adding an edge, is also matching covered. Thus, $H - uv + uv$, which is the same as $H' - e$, is also matching covered. Observe that $G - e$ may be obtained by splicing $H' - e$ and $W_5 - e$, each of which is matching covered, whence $G - e$ is also matching covered.

Finally, we argue why $b(G - e) = k$. Note that the set B is a barrier in $G - e$ and that $G - e - B$ has k nontrivial components (and one trivial component, namely the vertex v). In particular, $k - 1$ of the nontrivial components are triangles, and the last one is a 5-cycle. This yields a laminar family of k nontrivial tight cuts, and each of them produces exactly one brick (that is in fact isomorphic to K_4). Thus $b(G - e) = k$.

This completes the proof of Proposition 87. □

Acknowledgements

This work commenced when the first author was a postdoc at the University of Waterloo (Canada) and was visiting Massey University (New Zealand). A significant portion of this work was done while the first author was a postdoc at the University of Vienna, and also during his visit to UFMS Campo Grande (Brazil). The work was completed during his postdoc at the University of Campinas (Brazil). The first author extends his gratitude to all institutions involved, and especially to Jochen Könemann (Waterloo), and to Ilse Fischer (Vienna), for providing financial support for the aforementioned visits.

References

- [1] J. A. Bondy and U. S. R. Murty. *Graph Theory*. Springer, 2008.
- [2] G. Brinkmann, K. Coolsaet, J. Goedgebeur, and H. Mélot. House of Graphs: a database of interesting graphs. *Discrete Applied Math.*, 161(1-2):311–314, 2013. Available at <http://hog.grinvin.org>.

- [3] M. H. Carvalho, C. L. Lucchesi, and U. S. R. Murty. On a conjecture of Lovász concerning bricks. I. The characteristic of a matching covered graph. *J. Combin. Theory Ser. B*, 85:94–136, 2002.
- [4] M. H. Carvalho, C. L. Lucchesi, and U. S. R. Murty. On a conjecture of Lovász concerning bricks. II. Bricks of finite characteristic. *J. Combin. Theory Ser. B*, 85:137–180, 2002.
- [5] M. H. Carvalho, C. L. Lucchesi, and U. S. R. Murty. Optimal ear decompositions of matching covered graphs. *J. Combin. Theory Ser. B*, 85:59–93, 2002.
- [6] M. H. Carvalho, C. L. Lucchesi, and U. S. R. Murty. The perfect matching polytope and solid bricks. *J. Combin. Theory Ser. B*, 92:319–324, 2004.
- [7] M. H. Carvalho, C. L. Lucchesi, and U. S. R. Murty. How to build a brick. *Discrete Math.*, 306:2383–2410, 2006.
- [8] M. H. Carvalho, C. L. Lucchesi, and U. S. R. Murty. A generalization of Little’s theorem on Pfaffian graphs. *J. Combin. Theory Ser. B*, 102:1241–1266, 2012.
- [9] J. Edmonds, L. Lovász, and William R. Pulleyblank. Brick decomposition and the matching rank of graphs. *Combinatorica*, 2:247–274, 1982.
- [10] Ilse Fischer and C. H. C. Little. A characterisation of Pfaffian near bipartite graphs. *J. Combin. Theory Ser. B*, 82:175–222, 2001.
- [11] P. W. Kasteleyn. Dimer statistics and phase transitions. *J. Math. Phys.*, 4:287–293, 1963.
- [12] N. Kothari and U. S. R. Murty. K_4 -free and \overline{C}_6 -free planar matching covered graphs. *J. Graph Theory*, 82(1):5–32, 2016.
- [13] D. Král, J. S. Sereni, and M. Stiebitz. A new lower bound on the number of perfect matchings in cubic graphs. *SIAM J. Discrete Math.*, 23:1465–1483, 2009.
- [14] C. H. C. Little. A characterization of convertible $(0, 1)$ -matrices. *J. Combin. Theory Ser. B*, 18:187–208, 1975.
- [15] C. H. C. Little and F. Rendl. Operations preserving the Pfaffian property of a graph. *J. Austral. Math. Soc. (Series A)*, 50:248–275, 1991.
- [16] L. Lovász. Ear decompositions of matching-covered graphs. *Combinatorica*, 3:105–117, 1983.
- [17] L. Lovász. Matching structure and the matching lattice. *J. Combin. Theory Ser. B*, 43:187–222, 1987.
- [18] L. Lovász and M. D. Plummer. *Matching Theory*. Number 29 in Annals of Discrete Mathematics. Elsevier Science, 1986.
- [19] Fuliang Lu, Xing Feng, and Yan Wang. b -invariant edges in essentially 4-edge-connected near-bipartite cubic bricks. Available at [arXiv:1905.07301](https://arxiv.org/abs/1905.07301), 2019.
- [20] C. L. Lucchesi, M. H. Carvalho, N. Kothari, and U. S. R. Murty. On two unsolved problems concerning matching covered graphs. *SIAM J. Discrete Math.*, 32(2):1478–1504, 2018.

- [21] W. McCuaig. Pólya's permanent problem. *Electron. J. Combin.*, 11(1), #R79, 2004.
- [22] A. A. A. Miranda and C. L. Lucchesi. A polynomial time algorithm for recognizing near-bipartite Pfaffian graphs. *Electronic Notes in Discrete Mathematics*, 30:171–176, 2008. IV Latin-American Algorithms, Graphs and Optimization Symposium - LAGOS 2007, Chile.
- [23] S. Norine and R. Thomas. Minimally non-Pfaffian graphs. *J. Combin. Theory Ser. B*, 98:1038–1055, 2008.
- [24] N. Robertson, P. D. Seymour, and R. Thomas. Permanents, Pfaffian orientations and even directed circuits. *Ann. of Math. (2)*, 150:929–975, 1999.
- [25] The Sage Developers. *SageMath, the Sage Mathematics Software System (Version 8.7)*, 2019. <https://www.sagemath.org>.
- [26] W. T. Tutte. The factorization of linear graphs. *J. London Math. Soc.*, 22:107–111, 1947.
- [27] N. Wormald. Classifying k -connected cubic graphs. In A. F. Horadam and W. D. Wallis, editors, *Combinatorial Mathematics VI. Lecture Notes in Mathematics*, volume 748. Springer, Berlin, Heiderberg, 1979.